



NOXION[®]
Best in class lighting
LED KATALOG
2026

NOXION®

Best in class lighting

Räumlichkeiten beleuchten, Möglichkeiten nutzen

Unsere Marke

Im Jahr 2000 wurde World Wide Lighting in Eindhoven, bekannt als die Stadt der Lichter, gegründet. In den letzten zwei Jahrzehnten hat sich das Unternehmen dem Design (ODM), der Herstellung (OEM) und dem Vertrieb von Beleuchtungsprodukten für führende europäische Marken und Importeure gewidmet. 2015 brachte World Wide Lighting (WWL) seine eigene Beleuchtungsmarke Noxion auf den Markt, die rechtlich über die Tochtergesellschaft PICPAC B.V. geführt wird. Mit Noxion bietet WWL hochwertige Lösungen, die speziell auf Unternehmen und professionelle Anwender im europäischen Markt ausgerichtet sind.

Unsere Philosophie

Wir bei Noxion möchten ein Partner sein, auf den Sie sich immer verlassen können. Die europäische Beleuchtungsindustrie entwickelt sich schnell weiter, wobei der Schwerpunkt mehr denn je auf Energieeffizienz liegt. Aus diesem Grund entwickeln wir hochwertige LED-Beleuchtung, die nicht nur den heutigen europäischen Standards entspricht, sondern auch für die Zukunft gerüstet ist. Wir möchten, dass unsere Kunden auch in Zukunft Vertrauen in unsere Produkte haben.

Durch das Angebot innovativer und maßgeschneiderter Beleuchtungslösungen zu fairen Preisen streben wir danach, starke und dauerhafte Beziehungen zu unseren Kunden aufzubauen. Mit Noxion erhalten Sie eine hochwertige Beleuchtung, auf die Sie sich jahrelang verlassen können, sowie eine persönliche Beratung und Unterstützung, um den Erfolg Ihrer Projekte zu gewährleisten!

Möchten Sie sich unserer Mission anschließen?

Unser Engagement geht über die Bereitstellung erstklassiger LED-Beleuchtung hinaus – wir sind bestrebt eine nachhaltigere Welt zu schaffen. Wir glauben an inspirierende Veränderungen, indem wir zeigen, wie die Umstellung auf LED eine einfache, aber wirkungsvolle Möglichkeit ist, die globalen CO₂-Emissionen zu reduzieren. LED-Beleuchtung senkt nicht nur den Energieverbrauch erheblich, sondern trägt auch zum Umweltschutz bei, indem sie schädlichen Abfall reduziert.

Wir wissen, dass echte Nachhaltigkeit ein Prozess ist und keine schnelle Lösung. Deshalb setzen wir uns Jahr für Jahr aktiv für eine grünere, hellere Zukunft für kommende Generationen ein. Gemeinsam können wir den Weg zu einem gesünderen Planeten ebnen.

ÜBER NOXION

Unser Ziel ist es, der führende Anbieter für zuverlässige, hochwertige LED-Leuchten und Leuchtmittel zu werden. Wir unterstützen Unternehmen in ganz Europa dabei, energieeffiziente Beleuchtungslösungen einzusetzen und ihre Räume optimal zu gestalten. Unsere Mission ist es, Kosteneinsparungen, Nachhaltigkeit und Energieeffizienz einfach und zugänglich zu machen.

Wie hat sich die Marke Noxion in den letzten fünf Jahren entwickelt?

World Wide Lighting hat Noxion ursprünglich als preislich attraktive Alternative zu etablierten Marken auf den Markt gebracht und dabei hohe technische Standards mit wettbewerbsfähigen Preisen kombiniert. Auch heute steht Noxion für hohe Qualität zu fairen Konditionen. In den vergangenen fünf Jahren hat sich die Marke jedoch klar weiterentwickelt und eine eigenständige Identität aufgebaut. Unser strategischer Fokus liegt inzwischen auf professionellen LED-Leuchten. Damit haben wir uns als unabhängiger und verlässlicher Akteur im professionellen Beleuchtungsmarkt etabliert.

Wie ist Noxion im Beleuchtungsmarkt positioniert?

Noxion ist eine professionelle Beleuchtungsmarke, die in den Niederlanden speziell für elektrotechnische Installateure entwickelt wurde. Im Mittelpunkt stehen dabei zwei zentrale Aspekte: eine **hohe Lichteffizienz** und eine besonders **einfache Installation**.

- **Produktqualität:** Unsere Produkte werden in hochautomatisierten Fabriken hergestellt, die weltweit zu den Top 10 zählen und sowohl für ihre Größe und Reputation als auch für faire und ethische Arbeitsbedingungen bekannt sind.
- **Innovation:** Durch die enge Zusammenarbeit mit diesen Partnern integrieren wir modernste Technologien wie CCT- und Leistungsschalter, smarte Steuerungen sowie eine herausragende Lumen-pro-Watt-Effizienz.
- **Exklusivität:** Obwohl es günstigere Alternativen am Markt gibt, machen wir keine Kompromisse bei der Qualität. Vor Kurzem haben wir zudem ein Leuchtenportfolio eingeführt, das exklusiv unseren Installationspartnern zur Verfügung steht und gezielt zur Unterstützung ihres Geschäfts entwickelt wurde.

Wie sorgt Noxion dafür, langfristig präsent zu bleiben?

Unsere Wettbewerbsfähigkeit sichern wir durch die enge Zusammenarbeit mit dem Markt und durch flexible Lösungen für unterschiedliche Budgets.

- **Premiumlinien:** Bei unserer Delta-Pro-Panel-Serie arbeiten wir intensiv mit Installateuren zusammen, die besonderen Wert auf spezifische Eigenschaften legen. Dazu zählen beispielsweise ultraflache, seitlich beleuchtete Panels, die wir weiterhin anbieten, während viele Wettbewerber ausschließlich auf rückseitig beleuchtete Modelle setzen.
- **Preisgünstige Produktlinien:** Bei der Modellreihe Ecowhite orientieren wir uns konsequent an den Standards des E-Commerce-Marktes, um das optimale Gleichgewicht zwischen Qualität und Preis zu gewährleisten.
- **Individualisierung:** Gleichzeitig setzen wir auf Individualisierung. Unsere neuen Produktserien bieten verschiedene Treiberoptionen, unterschiedliche Kabel- und Anschlussvarianten sowie Zubehör wie Brandschutzkappen oder Reflektoren, die zusätzlich montiert werden.

Wir sind überzeugt, dass die wahren Experten diejenigen sind, die unsere Produkte täglich installieren. Deshalb schätzen wir Ihr praktisches Know-how und laden Sie ein, Ihre Ideen und Verbesserungsvorschläge direkt mit uns zu teilen. Wir hören Ihnen zu und entwickeln Lösungen, die Ihren Arbeitsalltag spürbar erleichtern.

Ed Huibers
CEO
Noxion & WWL



DAS NOXION SORTIMENT

Bei Noxion konzentrieren wir uns auf die Bereitstellung zuverlässiger, hochwertiger LED-Leuchten, Lichtquellen und Zubehörteile. Innovation steht im Mittelpunkt unseres Handelns und ermöglicht es uns, Branchenstandards zu erfüllen, zu übertreffen und gleichzeitig eine dauerhafte Leistung und Kundenzufriedenheit zu gewährleisten. Da wir Ihre individuellen Bedürfnisse verstehen, bieten wir Ihnen persönlichen Support und zahlreiche Services, um Sie bei fundierten Entscheidungen für Ihre Beleuchtungsprojekte zu unterstützen. Kurz gesagt, Noxion ist ...



Innovativ

Die Produktdesigns werden ständig aktualisiert, um die neueste LED-Technologie zu nutzen. So gewährleisten wir stets innovative Lösungen, die einfach zu installieren sind.



Anpassbar

Unsere neuesten Produkte verfügen über praktische Schalter, mit denen Sie die Beleuchtung in Bezug auf Wattzahl, Lumen und/oder Lichtfarbe einstellen können.



Nachhaltig

Unsere Produkte sind energieeffizient und langlebig. Wir arbeiten mit renommierten Marken zusammen und nutzen stets die besten Komponenten.









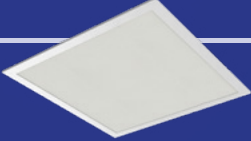

Noxion, Best in class lighting

Wir wollen ein komplettes LED-Sortiment anbieten, mit dem Sie mühelos qualitative Lichtlösungen in verschiedenen Anwendungen umsetzen können. Darüber hinaus können Sie mit unseren Produkten hohe Margen erzielen und Projekte gewissenhaft abschließen.

Noxion Kontakt

INHALTSVERZEICHNIS

01		LED Panels	P.08
02		LED Wannenleuchten	P.16
03		LED Lichtbandsysteme	P.24
04		LED Highbays	P.32
05		LED Fluter	P.36
06		LED Straßenbeleuchtung	P.42
07		LED Bulkheads	P.46
08		LED Streifen	P.50
09		LED Downlights	P.54

10		Notbeleuchtung	P.64
11		LED Schienenstrahler	P.70
12		Einbaustrahler	P.76
13		LED Strahler	P.82
14		LED Lampen	P.90
15		Gasentladungslampen	P.98
15		LED CFL Lampen	P.102
16		LED Stiftsockellampen	P.108
17		LED Röhren	P.112
18		LED Zubehör	P.120



LED PANELS



BESTE WAHL



**Delta Pro
V5.1 & V5**



**Delta Value
V5.1 & V5**



**Delta Pro Highlum
V5.1 & V5**



**Ecowhite
V4.0**

UGR	<19	<19 / <22	<19 / <22	<19 / <22
WATT	28W	28W	36W	13W - 64W
LUMEN	3700 - 3920	3700 - 3920	4860 - 5040	1200 - 7680
LM/W	140	140	140	121
TREIBER	Philips	Philips	Philips	Noxion Philips
DIMMBAR	DALI / TRIAC	DALI / TRIAC	✗	✗
SCHALTER	✗	CCT	CCT	CCT
LEBENSDAUER L70	100,000h	90,000h	100,000h	70,000h
GARANTIE	6 Jahre	6 Jahre	6 Jahre	4 Jahre
PREIS/LEISTUNG	Beste Wahl	Besser	Besser	Gut
BESONDERHEIT	Sidelit Lange Lebensdauer	Backlit CCT Schalter	Backlit Lange Lebensdauer	CCT Schalter

01 LED PANELS

LED Panel Delta Pro V5

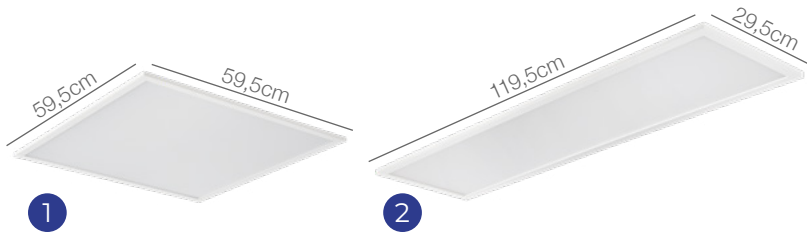

Sidelit Versionen verfügbar · Schnelle Verbindung · Mögliche Optionen: DALI/TRIAC · Mikroprismen-Linse & flimmerfrei · Sicherheitskabel inklusive · Philips Certadriver · 3000K, 4000K · CRI80 · 2 Größen verfügbar (60x60, 30x120) · 6-Jahre Garantie · UGR<19 · SDCM<3 · IP20 · IK02 · Klasse II · PF>0,95 · STAHL / AL / PS / PC · Betriebstemperatur -20~40°C · CE / RoHS / ENEC / DEKRA MARK



	Pro Sidelit V5.1 UGR<19	Standard	DALI	TRIAC	W	LM	LM/W	K				
1	28W 3700LM 3000K 60x60cm	252939	255299	255288	28	3700	132	3000	90°	100,000	595x595x10	
	28W 3920LM 4000K 60x60cm	252940	255300	255291	28	3920	140	4000				
2	28W 3700LM 3000K 30x120cm	252941	255301	255292	28	3700	132	3000	90°	100,000	295x1195x10	
	28W 3920LM 4000K 30x120cm	252942	255302	255293	28	3920	140	4000				

Weitere Informationen

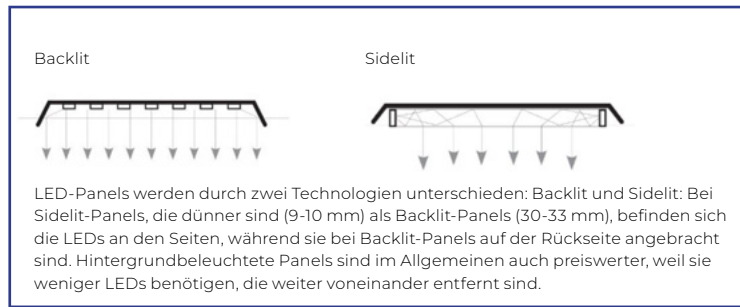



01 LED PANELS

LED Panel Delta Value V5



Backlit Versionen verfügbar · Schnelle Verbindung · Mögliche Optionen: DALI/TRIAC · Mikroprismen-Linse & flimmerfrei · Sicherheitskabel inklusive · Philips Certadrive · 2CCT Schalter (3000K, 4000K) · CRI80 · 3 Größen verfügbar (60x60, 62x62, 30x120) · 6-Jahre Garantie · UGR<22 oder UGR<19 · SDCM<3 · IP20 · IK02 · Klasse II · PF>0,95 · STAHL / AL / PS / PC · Betriebstemperatur -20~40°C · CE / RoHS / ENEC / DEKRA MARK



	#	W	LM	LM/W	K							
Value Backlit V5.1 UGR<19												
	Standard	DALI		TRIAC								
1	28W 2CCT 60x60cm	252933	255295	255285	28	3780/3920	135/140	3000/4000		90°	90,000	595x595x32
2	28W 2CCT 62x62cm	252934			28	3780/3920	135/140	3000/4000		90°	90,000	620x620x32
3	28W 2CCT 30x120cm	252936	255298	255287	28	3780/3920	135/140	3000/4000		90°	90,000	295x1195x32
Value Backlit V5.1 UGR<22												
1	28W 2CCT 60x60cm	252932		255284	28	3780/3920	135/140	3000/4000		120°	90,000	595x595x32
2	28W 2CCT 62x62cm		255296	255286	28	3780/3920	135/140	3000/4000		120°	90,000	620x620x32
3	28W 2CCT 30x120cm	252935	255297	255289	28	3780/3920	135/140	3000/4000		120°	90,000	295x1195x32

Weitere Informationen

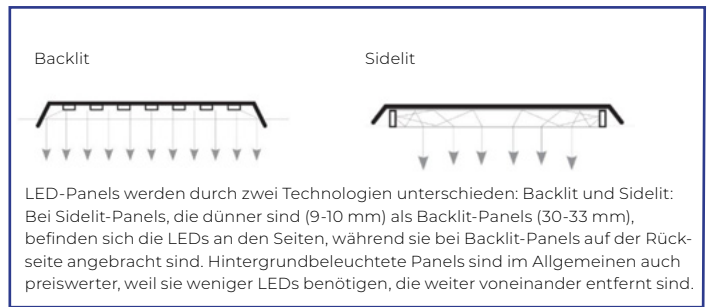
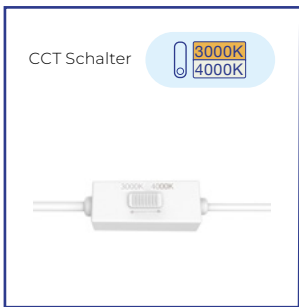



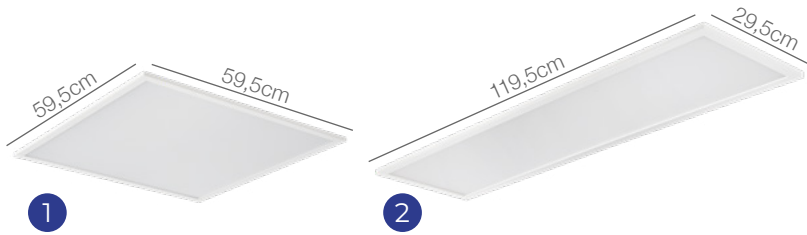

01 LED PANELS

LED Panel Delta Pro Highlum V5



Backlit & Sidelit Versionen verfügbar · Schnelle Verbindung · Mikroprismen-Linse & flimmerfrei · Sicherheitskabel inklusive · Philips Certadriver · 2 CCT Schalter (3000K, 4000K) · CRI80 · 2 Größen verfügbar (60x60, 30x120) · 6-Jahre Garantie · UGR<19 · SDCM<3 · IP20 · IK02 · Klasse II · PF>0,95 · STAHL / AL / PS / PC · Betriebstemperatur -20~40°C · CE / RoHS / ENEC / DEKRA MARK



		#	W	LM	LM/W	K				
	Pro Highlum Backlit UGR<19	Standard								
1	36W 2CCT 60x60cm	252937	36	4860/ 5040	135/ 140	3000/ 4000	×	90°	100,000	595x595x32
2	36W 2CCT 30x120cm	252938	36	4860/ 5040	135/ 140	3000/ 4000		90°	100,000	295x1195x32

Weitere Informationen

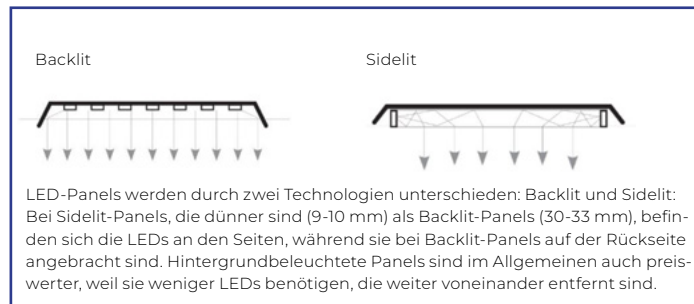

01 LED PANELS

LED Panels Ecowhite V4



Backlit · Mikropismen-Linse · Philips Treiber oder Noxion Treiber verfügbar · 3000K, 4000K, 6500K oder 3CCT (3000K, 4000K, 6500K) · CRI80 · 6 Größen verfügbar (60x60, 62x62, 30x120, 30x30, 30x60, 60x120) · 4-Jahre Garantie · UGR<22 oder UGR<19 · SDCM<6 · IP20 · IK02 · Klasse II · PF>0,9 · Aluminium / Eisen · Betriebstemperatur -20~40°C · CE / RoHS / ENEC



		#	W	LM	LM/W	K					
UGR<19		Philips Treiber									
1	28W 3200LM 3000K 60x60cm	248929	28	3200	114	3000	×	90°	70,000	595x595x34	
	28W 3400LM 4000K 60x60cm	248931	28	3400	121	4000		90°	70,000	595x595x34	
2	28W 3400LM 4000K 62x62cm	248933	28	3400	121	4000		90°	70,000	620x620x34	
	28W 3200LM 3000K 30x120cm	248934	28	3200	114	3000		90°	70,000	1195x295x25	
3	28W 3400LM 4000K 30x120cm	248936	28	3400	121	4000		90°	70,000	1195x295x25	
	UGR<22		Philips Treiber								
1	28W 3200LM 3000K 60x60cm	248928	28	3200	114	3000	×	120°	70,000	595x595x34	
	28W 3400LM 4000K 60x60cm	248930	28	3400	121	4000		120°	70,000	595x595x34	
	28W 3400LM 6500K 60x60cm	248932	28	3400	121	6500		120°	70,000	595x595x34	
3	28W 3400LM 4000K 30x120cm	248935	28	3400	121	4000		120°	70,000	1195x295x34	
CCT UGR<19		Philips Treiber									
1	28W 3CCT 60x60cm	250399	28	2800/3360/3000	100/120/107	3000/4000/6500	×	90°	70,000	595x595x34	
2	28W 3CCT 62x62cm	250401	28	2800/3360/3000	100/120/107	3000/4000/6500		90°	70,000	620x620x34	
3	28W 3CCT 30x120cm	250403	28	2800/3360/3000	100/120/107	3000/4000/6500		90°	70,000	1195x295x34	
CCT UGR<22		Philips Treiber	Noxion Treiber								
-	13W 3CCT 30x30cm	250404	251899	13	1200/1560/1300	92/120/100	3000/4000/6500	×	120°	70,000	295x295x34
-	20W 3CCT 30x60cm	250405		20	2000/2400/2100	100/120/105	3000/4000/6500		120°	70,000	595x295x34
1	28W 3CCT 60x60cm	250398	249157	28	2800/3360/3000	100/120/107	3000/4000/6500		120°	70,000	595x595x34
2	28W 3CCT 62x62cm	248939	249159	28	2800/3360/3000	100/120/107	3000/4000/6500		120°	70,000	620x620x34
3	28W 3CCT 30x120cm	248941		28	2800/3360/3000	100/120/107	3000/4000/6500		120°	70,000	1195x295x34
	250402										
-	64W 3CCT 60x120cm	250406		64	7000/7680/7500	109/115/117	3000/4000/6500		120°	70,000	1195x595x34

Weitere Informationen



01 LED PANELS

LED Panel Zubehör



		#	
		Delta Pro & Value V5.1 & V5	Ecowhite V4
1	Osram Treiber DALI 42/220-240/1050 CS 0.7-1.05A (DIP) 15-42V incl. DC Kabel Set at 700mA	249399	/
2	Noxion LED Panel Befestigungsclips (4 Stück)	236959	236959
3	Noxion LED Panel Aufhängungssatz	236958	236958
4	Sicherheitskabel 1.5m	/	236960
5	Noxion LED Panel Aufbaurahmen 60x60cm	238301	238301
5	Noxion LED Panel Aufbaurahmen 62x62cm	250795	250795
6	Noxion LED Panel Aufbaurahmen 30x120cm	238302	238302
5	Noxion LED Panel Aufbaurahmen 30x30cm	/	250796
7	Noxion LED Panel Aufbaurahmen 30x60cm	/	250797
7	Noxion LED Panel Aufbaurahmen 60x120cm	/	249169





LED WANNENLEUCHTEN

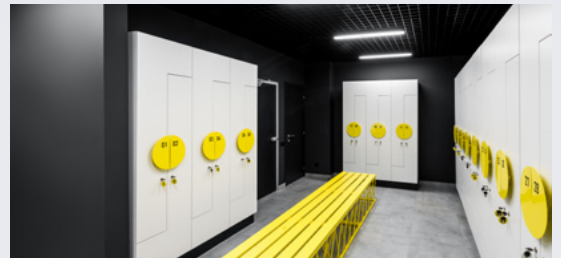

BESTE WAHL



Poseidon V3



Ecowhite V3



Poseidon V2
(Gehäuse)



T5 Batline V2



T8 batten
click V2

	Poseidon V3	Ecowhite V3	Poseidon V2 (Gehäuse)	T5 Batline V2	T8 batten click V2
WATT	10W - 65W	20W - 50W	-	4W - 19W	-
LUMEN	1300 - 9100	2400 - 6500	-	480 - 2500	-
LM/W	140	130	-	140	-
IP & IK	IP65 / IK10	IP65 / IK10	IP65 / IK08	IP20 / IK03	IP20 / -
TREIBER	Tridonic	Noxion	-	-	-
OPTIONEN	DALI Notmodul & Sensor	×	-	×	-
SCHALTER	CCT & Watt	CCT & Watt	-	CCT	-
LEBENSDAUER L70	80,000h	50,000h	-	25,000h	-
GARANTIE	6 Jahre	4 Jahre	4 Jahre	4 Jahre	4 Jahre
PREIS/LEISTUNG	Beste Wahl	Besser	Gut	Besser	Besser
BESONDERHEIT	CCT Schalter & Watt Durchgangsverdrahtung	CCT Schalter & Watt Durchgangsverdrahtung	Für T8 LED-Röhren	CCT Schalter Ein/Aus-Schalter	Für T8 LED-Röhren





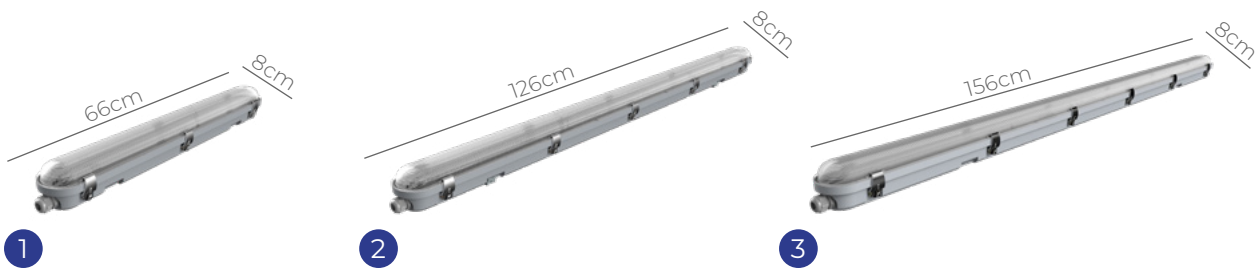



02 LED WANNENLEUCHTEN

LED Feuchtraumleuchte Poseidon V3



Durchgangsverdrahtung · Mögliche Optionen: DALI/Lichtsensoren/notbeluchtung · Watschalter · 3CCT Schalter (3000K, 4000K, 6500K) · 60/120/150cm längen · 6-Jahre Garantie · 130° · IP65 · IK10 · Klasse I · Polycarbonat · Betriebstemperatur -20~40°C · CE / RoHS / ENEC / KEMA-KEUR



Poseidon V3 CCT		Standard								
1	10/12/15/18W 3CCT 60cm	247473	10	1300/1400/1400	118/127/127	3000/4000/6500	130°	80,000	660x80x75	
			12	1560/1680/1680	120/130/130	3000/4000/6500				
			15	1950/2100/2100	130/140/140	3000/4000/6500				
			18	2340/2520/2520	130/140/140	3000/4000/6500				
2	18/21/26/30W 3CCT 120cm	247474	18	2340/2520/2520	130/140/140	3000/4000/6500	130°	80,000	1260x80x75	
			21	2730/2940/2940	130/140/140	3000/4000/6500				
			26	3380/3640/3640	130/140/140	3000/4000/6500				
			30	3900/4200/4200	130/140/140	3000/4000/6500				
3	19/23/27/32W 3CCT 150cm	248406	19	2340/2520/2520	123/133/133	3000/4000/6500	130°	80,000	1560x80x75	
			23	2730/2940/2940	119/128/128	3000/4000/6500				
			27	3380/3640/3640	125/135/135	3000/4000/6500				
			32	3900/4200/4200	122/131/131	3000/4000/6500				
	35/43/55/65W 3CCT 150cm	247475	247476	35	4550/4900/4900	130/140/140	3000/4000/6500	130°	80,000	1560x80x75
				43	5590/6020/6020	130/140/140	3000/4000/6500			
				55	7150/7700/7700	130/140/140	3000/4000/6500			
				65	8450/9100/9100	130/140/140	3000/4000/6500			
2	30W 3CCT 120cm	248407	248408	30	3900/4200/4200	130/140/140	3000/4000/6500	130°	80,000	1260x80x75
3	43W 3CCT 150cm		248409	43	5590/6020/6020	130/140/140	3000/4000/6500	130°	80,000	1560x80x75
	65W 3CCT 150cm	247478	247477	65	8450/9100/9100	130/133/133	3000/4000/6500	130°	80,000	1560x80x75
Poseidon V3 Optionen										
2	30W 3CCT 120cm	255402	251672	30	3900/4200/4200	130/140/140	3000/4000/6500	130°	80,000	1260x80x75
Poseidon V3 Einzelfarbe										
3	43W 6000LM 4000K 150cm	249629		43	6000	140	4000	130°	80,000	1560x80x75
	65W 9000LM 4000K 150cm	249630		65	9100	140	4000	130°	80,000	1560x80x75
Zubehör										
Rostfreie Klemmen		240965								
Aufputz-Halterung (2 Stück)		248876								
Haisen Bewegungs- und Lichtsensor HD011S		249065								



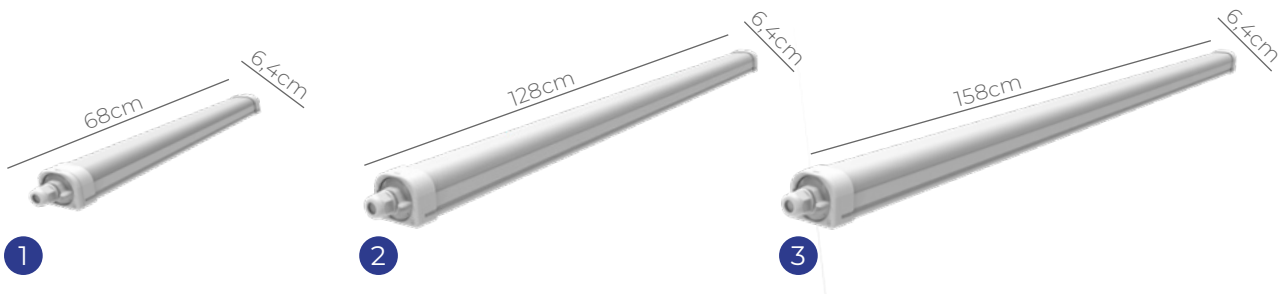

02 LED WANNENLEUCHTEN

LED Feuchtraumleuchte Ecowhite V3

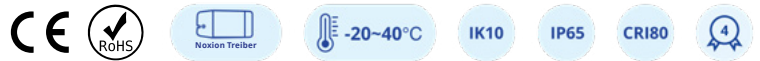

Durchgangsverdrahtung, einfache Installation · Wattschalter · 3CCT Schalter (3000K, 4000K, 6500K) · 60/120/150cm län- gen · 4-Jahre Garantie · 120° · IP65 · IK10 · Klasse II · Aluminium / Polycarbonat · Betriebstemperatur -20~40°C · CE / RoHS



	#	W	LM	LM/W	K			
1	20W 3CCT 60cm	20	2400/2600/2600	119/130/130	3000/4000/6500	X	120°	680x64x57
2	24/36W 3CCT 120cm	24	2900/3120/3120	119/130/130	3000/4000/6500		120°	1280x64x57
		36	4300/4680/4680	119/130/130	3000/4000/6500		120°	1280x64x57
3	36/50W 3CCT 150cm	36	4300/4680/4680	119/130/130	3000/4000/6500		120°	1580x64x57
		50	6000/6500/6500	119/130/130	3000/4000/6500		120°	1580x64x57

Weitere Informationen

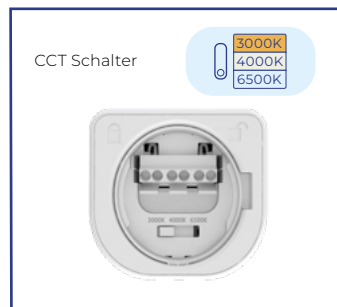
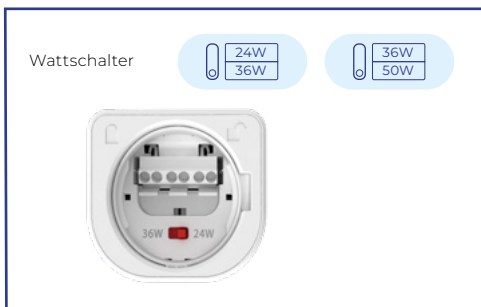

02 LED WANNENLEUCHTEN

LED Wannenneuchten (wasserdicht) Poseidon V2

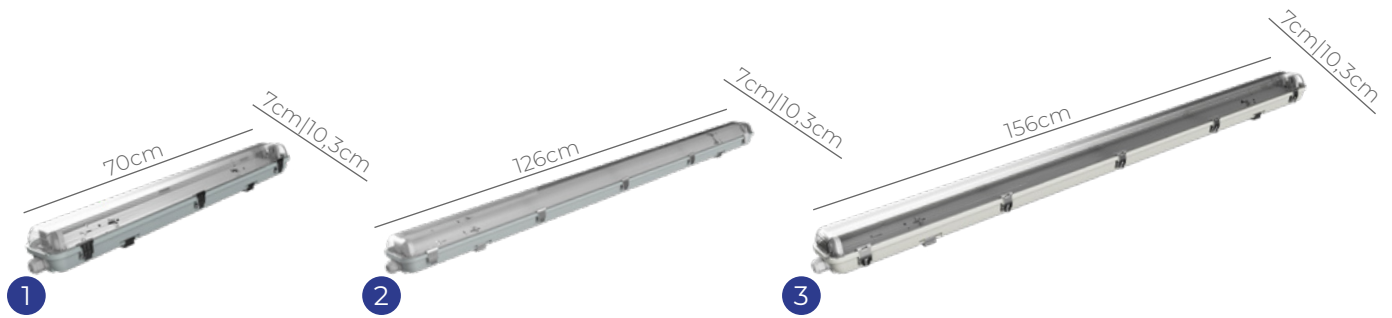

Geeignet für T8 G13 LED KVG oder UN Röhre · Stromversorgung 230V · 60/120/150cm Längen · 4-Jahre Garantie · IP65 · IK08
 · Klasse II · Polycarbonat · Betriebstemperatur -20~40°C · CE / RoHS



	Gehäuse Poseidon V2 + LED Röhren	#			W	LM	LM/W	×	50,000	660x70x68
		3000K	4000K	6500K						
1	60cm (Einzel) + 1 Röhre 9W 900LM	246780	246786	246792	9	900	100	×	50,000	660x70x68
	60cm (Doppel) + 2 Röhren 9W 2x900LM	246781	246787	246793	2x9	1800	100		50,000	660x103x68
2	120cm (Einzel) + 1 Röhre 17,5W 1800LM	246782	246788	246794	17,5	1800	103		50,000	1260x70x68
	120cm (Doppel) + 2 Röhren 17,5W 2x1800LM	246784	246789	246795	2x17,5	3600	103		50,000	1260x103x68
3	150cm (Einzel) + 1 Röhre 22W 2300LM	246783	246790	246796	22	2300	105		50,000	1560x70x68
	150cm (Doppel) + 2 Röhren 22W 2x2300LM	246785	246791	246797	2x22	4600	105		50,000	1560x103x68
Gehäuse Poseidon V2 (ohne LED-Röhren)										
1	60cm (Einzel)	237531								660x70x68
	60cm (Doppel)	237532								660x103x68
2	120cm (Einzel)	237533								1260x70x68
	120cm (Doppel)	237534								1260x103x68
3	150cm (Einzel)	237535								1560x70x68
	150cm (Doppel)	237536								1560x103x68

Weitere Informationen



02 LED WANNENLEUCHTEN

LED Wannenleuchte T5 Batline V2



Schalter an/aus · Endlosleitung möglich (4/8/11W max. 20 Stück, 15/19W max. 12 Stück) · Anschluss mit stecker · 3CCT Schalter (3000K, 4000K, 6500K) · 30/60/90/120/150cm Längen · 4-Jahre Garantie · 120° · IP20 · IK03 · Klasse II · Polycarbonat · Betriebstemperatur -20~40°C · CE / RoHS

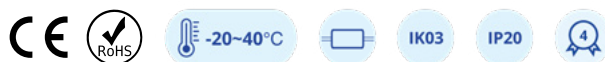

#	W	LM	LM/W	K	Refresh	Home	Clock	Mounting	
4W 3CCT 30cm	247468	4	480/530/520	120/133/130	3000/4000/6500	X	120°	25,000	288x22x57
8W 3CCT 60cm	247469	8	990/1080/1050	120/138/131	3000/4000/6500		120°	25,000	550x22x35
11W 3CCT 90cm	247470	11	1340/1420/1440	122/139/131	3000/4000/6500		120°	25,000	850x22x35
15W 3CCT 120cm	247471	15	1855/2020/1980	124/138/132	3000/4000/6500		120°	25,000	1150x22x35
19W 3CCT 150cm	247472	19	2370/2580/2500	125/140/132	3000/4000/6500		120°	25,000	1450x22x35

Weitere Informationen



02 LED WANNENLEUCHTEN

LED T8 Wannenleuchte Click / Reflektor V2

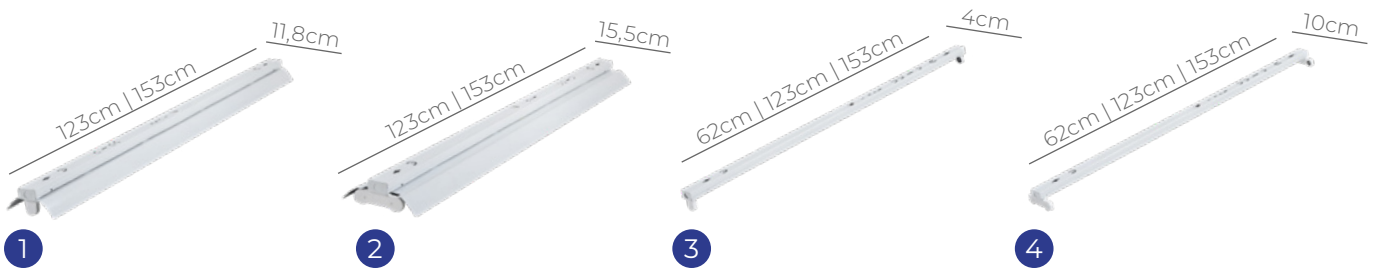

Geeignet für T8 G13 LED KVG oder UN Röhre · Mit Reflektor verfügbar · Stromversorgung 230V · Risikofrei für beidseitigen L/N-Einbau · 60/120/150cm Längen · 4-Jahre Garantie · IP20 · IK02 · Klasse I · Stahl · Betriebstemperatur -20~40°C · CE

T8-Röhren sind erhältlich auf Seite 109



Mit Reflektor				
1	1x36W 120cm	249482	X	1230x118x57
	1x58W 150cm	249483		1530x118x57
2	2x36W 120cm	249484		1230x155x55
	2x58W 150cm	249485		1530x155x55
Ohne Reflektor				
3	1x18W 60cm	249476	X	620x40x57
	1x36W 120cm	249477		1230x40x57
	1x58W 150cm	249478		1530x40x57
4	2x18W 60cm	249479		620x100x52
	2x36W 120cm	249480		1230x100x52
	2x58W 150cm	249481		1530x100x52

Weitere Informationen







LICHTBANDSYSTEME



BESTE WAHL



Easy Trunk



NX-Line V3 & V2



Retrofit

	Easy Trunk	NX-Line V3 & V2	Retrofit
WATT	60W	35W - 70W	32W - 55W
LUMEN	9000	6300 - 13650	12025
LM/W	150	180 - 195	170
IP / IK	IP40 / IK06	IP20 / IK04	IP20 / IK10
OPTIONEN	0-10V & Notmodul	DALI & Notmodul	Notmodul
SCHALTER	✗	Watt	Watt
LEBENSDAUER L70	72,000h	70,000h - 50,000h	50,000h
GARANTIE	6 Jahre	6 Jahre	5 Jahre
PREIS/LEISTUNG	Besser	Beste Wahl	Gut
BESONDERHEIT	Passt zu vielen Marken Verwendung in Renovierungs- projekten	Wattschalter Verschiedene Abstrahlwinkel Verwendung in neuen Projekten	Wattschalter Verstellbare Halterungen

03 LICHTBANDSYSTEME

Lichtbandsystem Easy Trunk

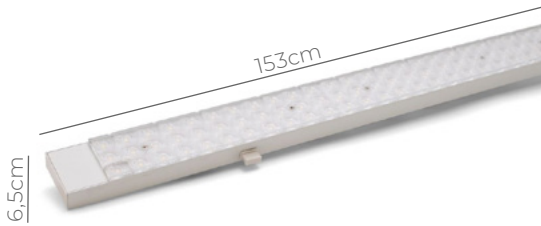

Einfacher Austausch der bestehenden Anlage (siehe Herstellerliste) · Mögliche Optionen: DALI/0-10V/Notbeleuchtung · 6-Jahre Garantie · Abstrahlwinkel 30°/60°/90°/120° · IP40 · IK06 · Klasse I · PF>0,9 · Aluminium

<div style="display: flex; justify-content: space-between; align-items: center;"> <div style="display: flex; gap: 10px;"> # W LM LM/W K </div> <div style="display: flex; gap: 10px;"> -10~45°C IK06 IP40 CRI80 6 </div> </div>										
Easy Trunk - NLS	Standard									
Easy Trunk - NLS-R58-840-90°	244235		60	9000	150	4000	✕	90°	72,000	1530x65x30
Easy Trunk - NLS-R58-850-90°	236982		60	9000	150	5000		90°	72,000	1530x65x30
Easy Trunk - RIDI										
Easy Trunk - RIDI VLG-T8-850-90°	236991		60	9000	150	5000	✕	90°	72,000	1530x65x30
Easy Trunk - RIDI VLG-T8-850-120°	248654	248653	60	9000	150	5000		120°	72,000	1530x65x30
Easy Trunk - SITECO										
Easy Trunk - Siteco-mod-850-90°	237000		60	9000	150	5000	✕	90°	72,000	1530x65x30
Easy Trunk - AEG										
Easy Trunk - AEG GLX TS-865-90°	248637	248638	60	9000	150	6500	✕	90°	72,000	1530x65x30
Easy Trunk - TTX										
Easy Trunk - TTX400-T5-840-90°	238452		60	9000	150	4000	✕	90°	72,000	160x20x20
Easy Trunk - TTX400-T8-840-90°	238439		60	9000	150	4000		90°	72,000	160x20x20
Easy Trunk - TTX400-T8-850-30°	243398		60	9000	150	5000		30°	72,000	160x20x20
Easy Trunk - TTX400-T8-850-90°	237012	237013	60	9000	150	5000		90°	72,000	160x20x20
EasyTrunk - TTX200-58W-840-90°	237527		60	9000	150	4000		90°	72,000	160x20x20
Easy Trunk - TTX200-58W-850-90°	237007		60	9000	150	5000		90°	72,000	160x20x20
Easy Trunk - VEKO										
Easy Trunk - VEKO PNR NEW-840-120°	245193		60	9000	150	4000	✕	120°	72,000	160x20x20
Easy Trunk - VEKO PNR NEW-850-90°	237021 245747	237022 247667	60	9000	150	5000		90°	72,000	160x20x20
Easy Trunk - ZUM										
Easy Trunk - ZUM tecton-850-90°	237020		60	9000	150	5000	✕	90°	72,000	160x20x20
Easy Trunk - ZUM-ZX1-850-90°	237014	237015	60	9000	150	5000		90°	72,000	160x20x20
Easy Trunk - ZUM-ZX2-T8-850-90°	237018	237019	60	9000	150	5000		90°	72,000	160x20x20
Easy Trunk - TMX204										
Easy Trunk TMX204 T8-58W-840-90°	237026	248909	60	9000	150	4000	✕	90°	72,000	160x20x20
Easy Trunk TMX204 T8-58W-840-120°	237025		60	9000	150	4000		120°	72,000	160x20x20

03 LICHTBANDSYSTEME

Lichtbandsystem NX-Line V3 & V2



Kontinuierliche Linie ideal für große Flächen · Mögliche Optionen: DALI/Notbeleuchtung/Sensor/UGR<19 · Watschalter · 4.000K · 6-Jahre Garantie · Abstrahlwinkel 30°/60°/90°/120° · IP20 · IK04 · Klasse I · PF>0,9 · Stahl / PMMA · Betriebstemperatur -20~40°C



V2 70W												
		Standard		DALI		3H						
70W 4000K FD120 WH (PC Diffuser)	248169			70	12600	180	4000	✓	FD-120°	50,000	1500x60x40	
70W 4000K FD120 WH	248174	251849		70	12600	180	4000		FD-120°	50,000	1500x60x40	
70W 4000K SP30 WH	248175			70	12600	180	4000		SP-30°	50,000	1500x60x40	
V2 Schalter 55/60/65/70W												
55/60/65/70W 4000K NR60 WH (Individual Lens Optic)	248187	248167		55/60/65/70	9900/10800/11700/12600	180	4000	👁️	NR-60°	50,000	1500x60x40	
55/60/65/70W 4000K WD90 WH (Individual Lens Optic)	248188	248168		55/60/65/70	9900/10800/11700/12600	180	4000		WD-90°	50,000	1500x60x40	
55/60/65/70W 4000K SP30 WH (Central Line Lens Optic)	248189			55/60/65/70	9900/10800/11700/12600	180	4000		SP-30°	50,000	1500x60x40	
55/60/65/70W 6500K SP30 WH (Central Line Lens Optic)	249236			55/60/65/70	9900/10800/11700/12600	180	6500		SP-30°	50,000	1500x60x40	
V3 Schalter 35/40/45/50W												
35/40/45/50W 4000K WD90 WH (Central Line Lens Optic)	252820	250373		35/40/45/50	6825/7800/8775/9750	195	4000	✕	WD-90°	70,000	1500x60x40	
35/40/45/50W 4000K FD120 WH (Central Line Lens Optic)	252824	252970		35/40/45/50	6825/7800/8775/9750	195	4000		FD-120°	70,000	1500x60x40	
35/40/45/50W 4000K FD120 WH (PC Diffuser)	252822	251851		35/40/45/50	6825/7800/8775/9750	195	4000		FD-120°	70,000	1500x60x40	
V3 Schalter 40/50/60/70W												
40/50/60/70W 4000K WD90 WH (Individual Lens Optic)	252826	254696		40/50/60/70	7800/9750/11700/13650	195	4000	👁️	WD-90°	70,000	1500x60x40	
40/50/60/70W 4000K NR60 WH		255941		40/50/60/70	7800/9750/11700/13650	195	4000		NR-60°	50,000	1500x60x40	
V3 Schalter 55/60/65/70W												
55/60/65/70W 4000K FD120 WH (Central Line Lens Optic)	252844	250375	256105	252983	55/60/65/70	10725/11700/12675/13650	195	4000	👁️	FD-120°	70,000	1500x60x40
55/60/65/70W 4000K WD90 WH (Central Line Lens Optic)	252821	248173	252931	253253	55/60/65/70	10725/11700/12675/13650	195	4000		WD-90°	70,000	1500x60x40

Weitere Informationen

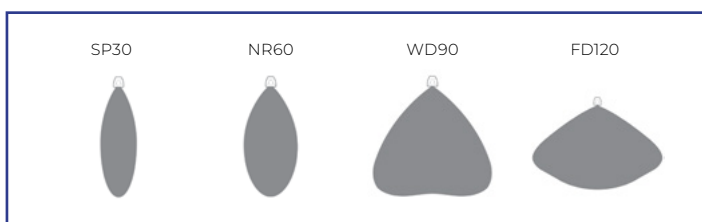

03 LICHTBANDSYSTEME

NX-Line Zubehör

Tragschienen



#

Tragschiene 8/1500 WH	235031
Tragschiene 8/1500 Endstück WH	235032
Tragschiene 8/3000 WH	235033
Tragschiene 8/3000 Endstück WH	235034

Aufhängungsätze & Montage

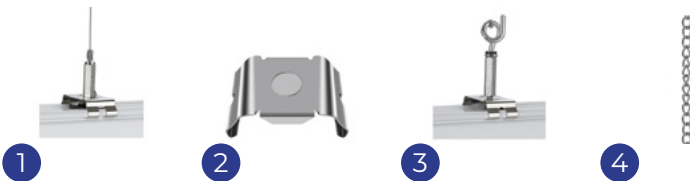

#

1	Seilabhängung 3M	235131
2	Clip zur Oberflächenmontage ø13.5mm	235137
3	Aufhängungshaken (ohne Kette)	245483
4	Aufhängungskette	248170

Abdeckungen



#

1	Blindabdeckung exkl. Kappen 1500WH	235135
2	Blindabdeckkappen WH	235136 237520
3	Endkappe WH	235139
4	Endkappe Blind/ Track Light/ Sensor Abdeckung WH	235141

Verbindungsstücke & Weiteres

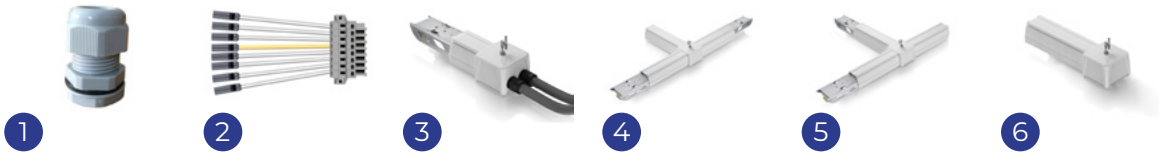

	#		
1	Kabeldurchführung M20x1.5m ø7mm-14mm	235142	
2	Einspeiseverbinder 8	235144	
3	Einspeisebox 8 WH	235145	
4	Knotenpunkt-Verbinder T OIO 8 WH	235150	
5	Knotenpunkt-Verbinder T OOI 8 WH	235151	
6	Einspeisebox 8 WH	253988	

Sensoren & Weiteres



	#		
1	Abdeckung 8/1.500 WH	235153	
2	DALI PS	235157	
3	Sensor Abdeckung 8/1.500 WH	235154	

Abdeckungen



#		
300mm NR60 Abdeckungen für NX Leuchten	244324	
300mm WD90 Abdeckungen für NX Leuchten	244325	
300mm FD120 Abdeckungen für NX Leuchten	244326	

03 LICHTBANDSYSTEME

Lichtbandsystem Retrofit



Durchgezogene Linie ideal für große Flächen · Mögliche Optionen: Notbeleuchtung · Wattschalter · 4000K & 5700K · 5-Jahre Garantie · Abstrahlwinkel 60°/90°/120° · IP20 · IK10 · Klasse I · PF>0,9 · Aluminium · Betriebstemperatur -20~40°C



Retrofit	Standard	3H								
32/40/48/55W 4000K 60°	257850		32/40/48/55	Max 9795	170	4000	×	60°	50,000	1470x65
32/40/48/55W 5700K 60°	257849		32/40/48/55	Max 9795	170	5700		60°	50,000	1470x65
32/40/48/55W 4000K 90°	257848	257851	32/40/48/55	Max 12580	160	4000		90°	50,000	1470x65
32/40/48/55W 5700K 90°	257847		32/40/48/55	Max 12025	160	5700		90°	50,000	1470x65
32/40/48/55W 4000K 120°	257846		32/40/48/55	Max 9175	155	4000		120°	50,000	1470x65
32/40/48/55W 5700K 120°	257845		32/40/48/55	Max 9175	155	4000		120°	50,000	1470x65
Tragschiene Stecker										
Plug Philips TTX200	257854									
Plug Philips TTX-400 / Philips Maxos	257853									
Plug Siemens	257859									
Plug Zumtobel ZX2	257858									
Plug Zumtobel Regiolux SMT / Regolux SPT / Veko old	257857									
Plug Zumtobel Norton / siteco DUS / Fluolite TRX	257856									
Plug Zumtobel/Veko new PRN / Trilux new	257855									
Plug Zumtobel ZX1	257852									

Weitere Informationen







LED HIGHBAYS

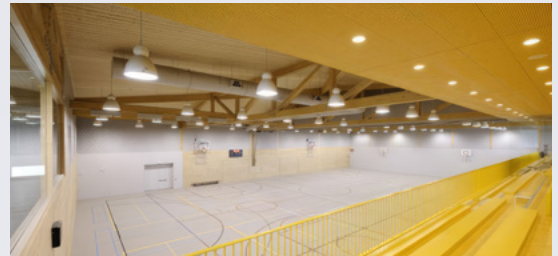

BESTE WAHL



Concord V4



Ecowhite V2

WATT	100W - 200W	100W - 200W
LUMEN	17000 - 34000	16000 - 32000
LM/W	170	160
IP / IK	IP65 / IK08	IP65 / IK08
OPTIONEN	DALI & 0-10V	0-10
SCHALTER	CCT & Watt	✗
LEBENSDAUER L70	140,000h	100,000h
GARANTIE	6 Jahre	4 Jahre
PREIS/LEISTUNG	Beste Wahl	Besser
BESONDERHEIT	CCT Schalter & Watt Sensor kompatibel	Sensor kompatibel

04 LED HIGHBAYS

LED Highbay Concord V4



Ideal für die Installation zwischen 4 und 14 Metern · Montagehaken mitgeliefert · Zubehör erhältlich: Sensor, Fernbedienung, Reflektor und Halterung · Wattschalter 100/120/150/200W · 3CCT Schalter (4000K, 5200K, 6500K) · 6-Jahre Garantie · 0-10V dimmbar · DALI 2 (kein Push-Dim) · 60°, 90° oder 120° · IP65 · IK08 · Klasse I · PF>0,9 · ACD12 / PC / Aluminium · Betriebstemperatur -30~50°C · CE / RoHS / ENEC



		#	W	LM	LM/W	K				
		0-10V		DALI						
1	100/120/150/200W 3CCT 90D 0-10V	249174 252814	100/120/ 150/200	17000/20400/ 24750/33000	170/170/ 165/165	4000	✓	90°	140,000	Ø297x120
				17500/21000/ 25500/34000	170/170/ 165/165	5200				
				17000/20400/ 24750/33000	170/170/ 165/165	6500				
	100/120/150/200W 3CCT 120D 0-10V	249175 252832	100/120/ 150/200	17500/21000/ 25500/34000	170/170/ 165/165	4000		120°	140,000	Ø297x120
				17000/20400/ 24750/33000	170/170/ 165/165	5200				
	200W 4000K 60D DALI	253103	200	34000	170	4000	60°	100,000	Ø297x107	
	200W 4000K 90D DALI	249641	200	34000	170	4000	90°	100,000	Ø297x107	
Zubehör										
	2	PC Diffusor mit Abdeckung	249366							
	3	60° Abstrahlwinkel Abdeckung	249367							
	3	90° Abstrahlwinkel Abdeckung	250432							
	3	120° Abstrahlwinkel Abdeckung	249644							
	4	Halterung	249368							
	5	Fernbedienung	249369							
	6	Mikrowellensensor	249370							

Weitere Informationen

Wattschalter & CCT

Sensor
(nicht für die DALI Version)

Offener Haken
(nicht für die DALI Version)

Wasserdichte Verbindung
(Inkl. DALI & Strom)

04 LED HIGHBAYS

LED Highbay Ecowhite V2



Ideal für die Installation zwischen 4 und 14 Metern · Befestigungshaken im Lieferumfang enthalten · Zubehör verfügbar: Sensor, Fernbedienung, Reflektor und Halterung · 100W oder 200W · 4000K · 6-Jahre Garantie · 0-10V dimmbar · 90 oder 120° · IP65 · IK08 · Klasse I · PF>0,9 · Aluminium/PC · Betriebstemperatur -30~50°C · CE / RoHS

<div style="display: flex; justify-content: space-between; align-items: center;"> <div style="display: flex; gap: 10px;"> CE RoHS -30~50°C IK08 IP65 CRI80 6 </div> </div>											
<div style="display: flex; justify-content: space-between; align-items: center;"> <div style="display: flex; gap: 10px;"> 0-10V </div> <div style="display: flex; gap: 10px;"> W LM LM/W K 90° 120° 100,000 Ø </div> </div>											
1	100W 16000LM 4000K 90D 1-10V	249170	100	16000	160	4000	✓	90°	100,000	Ø263x150	
	100W 16000LM 4000K 120D 1-10V	249171	100	16000	160	4000		120°	100,000	Ø263x150	
	200W 32000LM 4000K 90D 1-10V	249172	200	32000	160	4000		90°	100,000	Ø300x152	
	200W 32000LM 4000K 120D 1-10V	249173	200	32000	160	4000		120°	100,000	Ø300x152	
Zubehör											
2	PC Diffusor mit Abdeckung	249366									
3	60° Abstrahlwinkel Abdeckung	249367									
3	120° Abstrahlwinkel Abdeckung	249644									
4	Halterung	249368									
5	Fernsteuerung	249369									
6	Mikrowellensensor	249370									

*Nur kompatibel mit 200-W-Versionen

Weitere Informationen

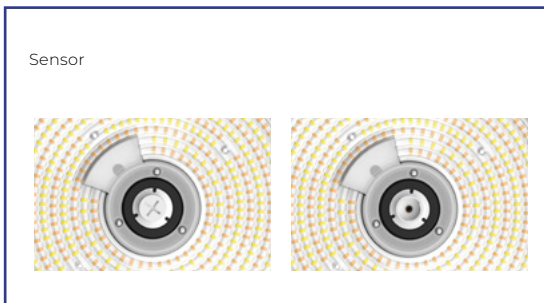



LED FLUTER



Beamy G3.1



Beam V2

BESTE WAHL

ProBeam V2

WATT	10W - 50W	40W - 100W	130W - 210W
LUMEN	1100 - 5500	5600 - 14000	18200 - 29400
LM/W	110	140	140
IP / IK	IP65 / IK07	IP66 / IK08	IP66 / IK08
OPTIONEN	Sensor	×	Zhaga Fassung
SCHALTER	×	CCT & Watt	CCT & Watt
LEBENSDAUER L70	30,000h	150,000h	150,000h
GARANTIE	4 Jahre	6 Jahre	6 Jahre
PREIS/LEISTUNG	Gut	Besser	Beste Wahl
BESONDERHEIT	Sensor PIR	CCT Schalter & Watt	CCT Schalter & Watt

05 LED FLUTER

LED Fluter Beamy G3.1

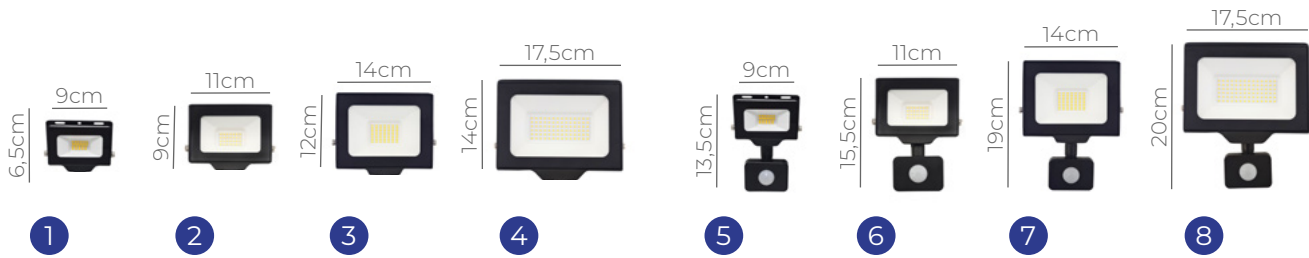

Inklusive PIR-Sensor (steckbar) · Kabel 1m für einfache Installation · Der Sensor kann leicht entfernt werden · 10W 20W 30W oder 50W · 3000K oder 4000K · 4-Jahre Garantie · Symmetrisch 100°/110° · Sensor IP44 - Leuchte IP65 · IK07 · Klasse I · PF>0,9 · Aluminium/Glas/PC · Betriebstemperatur -20~40°C · CE / RoHS



		#	W	LM	LM/W	K				
Standard										
1	10W 1100LM 3000K Sensor	253264	10	1100	110	3000	×	100°	30,000	90x65x28
	10W 1100LM 4000K Sensor	253265	10	1100	110	4000		100°	30,000	90x65x28
2	20W 2200LM 3000K Sensor	253266	20	2200	110	3000		100°	30,000	110x90x28
	20W 2200LM 4000K Sensor	253267	20	2200	110	4000		100°	30,000	110x90x28
3	30W 3300LM 3000K Sensor	253268	30	3300	110	3000		110°	30,000	140x120x28
	30W 3300LM 4000K Sensor	253269	30	3300	110	4000		110°	30,000	140x120x28
4	50W 5500LM 3000K Sensor	253270	50	5500	110	3000		110°	30,000	175x140x28
	50W 5500LM 4000K Sensor	253271	50	5500	110	4000		110°	30,000	175x140x28
PIR Sensor										
1	10W 1100LM 3000K PIR Sensor	253393	10	1100	110	3000	×	100°	30,000	90x135x48
	10W 1100LM 4000K PIR Sensor	253394	10	1100	110	4000		100°	30,000	90x135x48
2	20W 2200LM 3000K PIR Sensor	253395	20	2200	110	3000		100°	30,000	110x155x48
	20W 2200LM 4000K PIR Sensor	253396	20	2200	110	4000		100°	30,000	110x155x48
3	30W 3300LM 3000K PIR Sensor	253397	30	3300	110	3000		110°	30,000	140x190x48
	30W 3300LM 4000K PIR Sensor	253398	30	3300	110	4000		110°	30,000	140x190x48
4	50W 5500LM 3000K PIR Sensor	253399	50	5500	110	3000		110°	30,000	175x200x48
	50W 5500LM 4000K PIR Sensor	253400	50	5500	110	4000		110°	30,000	175x200x48

Weitere Informationen







LED STRASSENBELEUCHTUNG



Straßenleuchte

WATT	30W - 150W
LUMEN	3600 - 18000
LM/W	120
IP / IK	IP65 / IK06
OPTIONEN	Tageslichtsensor
SCHALTER	×
LEBENSDAUER L70	25,000h
GARANTIE	4 Jahre
PREIS/LEISTUNG	Gut
BESONDERHEIT	Tageslichtsensor

05 LED STRASSENBELEUCHTUNG

LED Straßenleuchten



Mögliche Optionen: mit Lichtsensor · 30W 50W 70W 100W oder 150W · 4.000K · 4-Jahre Garantie · Asymmetrisch 70x140°
 · IP65 · IK06 · Klasse I · Betriebstemperatur -20~40°C · CE / RoHS



		#	W	LM	LM/W	K					
		Standard ☺ ☀									
1	30W 3600LM 4000K	249066	30	3600	120	4000	X	Typ III	25,000	416x138x105	
2	50W 6000LM 4000K	249067 249071	50	6000	120	4000		Typ III	25,000	470x149x105	
3	70W 8400LM 4000K	249068 249072	70	8400	120	4000		Typ III	25,000	470x149x105	
4	100W 12000LM 4000K	249069 249073	100	12000	120	4000		Typ III	25,000	567x179x105	
5	150W 18000LM 4000K	249070 249074	150	18000	120	4000		Typ III	25,000	633x203x105	

Weitere Informationen

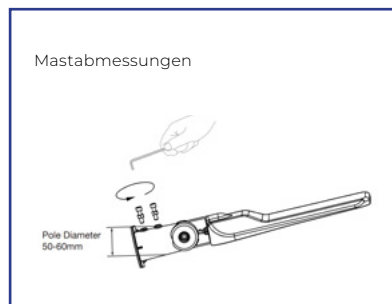





LED BULKHEADS



BESTE WAHL



Pro V2



Corido V2







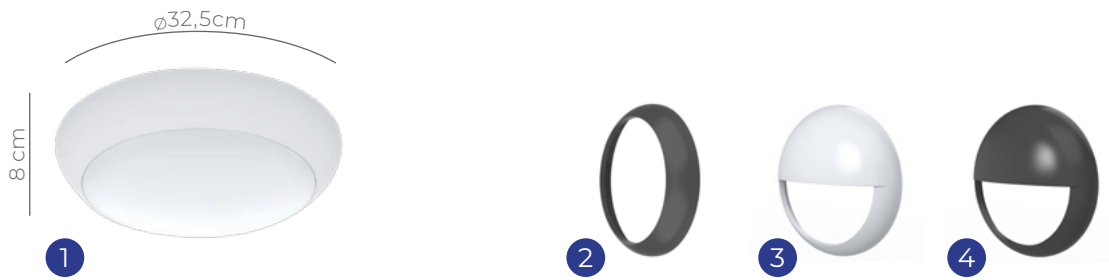



WATT	12/16/20W	12/16/20W
LUMEN	Max 2400	Max 2000
LM/W	120	100
IP / IK	IP65 / IK10	IP44 / IK02
OPTIONEN	Sensor & Notmodul	Sensor & Notmodul
SCHALTER	CCT & Watt	CCT & Watt
LEBENSDAUER L70	100,000h	100,000h
GARANTIE	6 Jahre	4 Jahre
PREIS/LEISTUNG	Beste Wahl	Gut
BESONDERHEIT	Sensor & Notmodul Schwarzer Ring & Augenlid	Sensor & Notmodul

07 LED BULKHEADS

LED Bulkhead Pro V2



Vandalismussichere Halterung · Ideal für Flure, Treppenhäuser, Parkhäuser · Mögliche Optionen: Sensor-/mit Notmodul oder beides · Ring & Augenlidring erhältlich in Schwarz oder Weiß · Wattschalter · 3CCT Schalter (3000K, 4000K, 6500K) · 6-Jahre Garantie · 120° · IP65 · IK10 · Klasse II · PF>0,9 · Polycarbonat · Betriebstemperatur -20~40°C · CE / RoHS

						CE	RoHS	-20~40°C	IK10	IP65	CRI80	6	
	#					W	LM	LM/W	K				
Standard 													
													
1	12/16/20W 3CCT Ø32,5cm Weiß	251982	251984	251983	251985	12/16/20	1450/1920/2400	120	3000/4000/6500	×	120°	100,000	Ø325x80
Zubehör													
2	Ring - Schwarz	251992											
3	Augenlid Ring - Weiß	251993											
4	Augenlid Ring - Schwarz	251994											
	Sensor	251990											
	Notfallmodul	251991											

Weitere Informationen

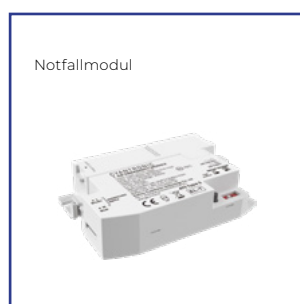













07 LED BULKHEADS

LED Deckenleuchte Corido V2



Effiziente Deckenbeleuchtung · Ideal für Flure, Treppenhäuser und Badezimmer · Mögliche Optionen: Sensor / Notmodul version oder beide · Wattschalter · 3CCT Schalter (3000K, 4000K, 6500K) · 4-Jahre Garantie · 120° · IP44 · IK02 · Klasse I · Aluminium / polycarbonate / PMMA · Betriebstemperatur -20~40°C · CE / RoHS

						CE			IK02	IP44	CRI80		
	#					W	LM	LM/W	K				
Standard  ·  ·  + 													
1	12/16/20W 3CCT Ø38cm Weiß	251986	251988	251987	251989	12/16/20	1200/1600/2000	100	3000/4000/6500	×	120°	100,000	Ø380x10
Zubehör													
Sensor		251990											
Notfallmodul		251991											

Weitere Informationen





LED STREIFEN



Naga

WATT	4,8W/m - 16W/m
LUMEN	310 - 1440
LM/W	90lm/w
IP / IK	IP65 & IP20
OPTIONEN	CCT für Dual weiß & RGB
SCHALTER	CCT
LEBENSDAUER L70	50,000h
GARANTIE	6 Jahre
PREIS/LEISTUNG	Beste Wahl
BESONDERHEIT	COB & SMD Viele Zubehörteile verfügbar

08 LED STREIFEN

LED Streifen Naga



COB & SMD · 5-Meter-Rolle · 2700K, 3000K, 4000K & 6500K · Einfarbige LED-Streifen werden mit einem Gleichstromkabel geliefert · Dualweiß & RGB · 6-Jahre Garantie · 120° & 180° · IP20 & IP65 · Klasse III · Betriebstemperatur -20~45°C · CE / RoHS



		#												
		2700K	3000K	4000K	6500K	Dual weiß	RGB + Dual weiß	W/M	LM/M	LM/W	✓	✓	✓	✓
IP20														
1	SMD60 4.8W/m 5M	252781	252782	252783	252784			4,8	Max 600	125	✓	120°	50,000	5000mm
2	SMD120 9.6W/m 5M	252785	252786	252787	252788			9,6	Max 870	91		120°	50,000	5000mm
3	SMD240 16W/m 5M	252789	252790	252791	252792			16	Max 1440	90		120°	50,000	5000mm
4	COB320 8W/m 5M	252793	252794	252795	252796			8	Max 950	119		180°	50,000	5000mm
5	SMD120 9.6W/m CCT 5M					251642		9,6	Max 430	45		120°	50,000	5000mm
6	SMD90 12W/m RGB+CCT 5M						251640	12	Max 310	25		120°	50,000	5000mm
IP65														
1	SMD60 4.8W/m 5M	251644	251646	251648	251650			4,8	Max 600	125	✓	120°	50,000	5000mm
2	SMD120 9.6W/m 5M	251652	251654	251609	251611			9,6	Max 870	91		120°	50,000	5000mm
3	SMD240 16W/m 5M	251613	251615	251617	251619			16	Max 1440	90		120°	50,000	5000mm
4	COB320 8W/m 5M	251621	251623	251625	251627			8	Max 950	119		180°	50,000	5000mm
5	SMD120 9.6W/m CCT 5M					251631		9,6	Max 430	45		120°	50,000	5000mm
6	SMD90 12W/m RGB+CCT 5M						251629	12	Max 310	25		120°	50,000	5000mm

Weitere Informationen

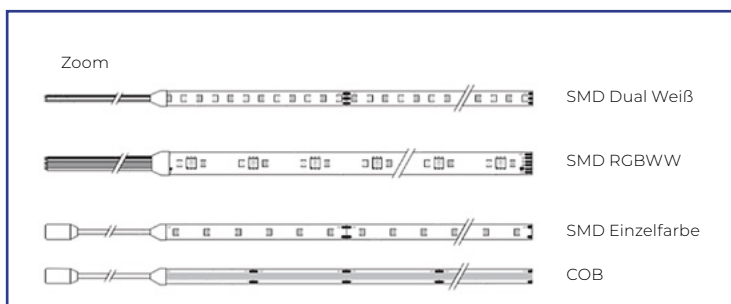

Treiber



	#	
	IP20	IP65
35W + 2M Stromkabel	251941	-
50W + 2M Stromkabel	251942	-
75W + 2M Stromkabel	251943	251948
100W + 2M Stromkabel	251944	251949
150W + 2M Stromkabel	251945	251950
200W + 2M Stromkabel	251946	251951
320W + 2M Stromkabel	-	251952
400W + 2M Stromkabel	251947	-

Zubehör



		#			
		SMD60/120 & COB320 Einzelfarbe	SMD240 Einzelfarbe	SMD120 Dual weiß	SMD90 RGB + Dual weiß
1	Watt DC Kabel	251633	251633	-	-
2	Streifen Verbinder	251635	251645	251655	251657
3	Streifen / Kabel Verbinder	251637	251647	251656	251658
4	15cm Streifen Verbinder	251639	251649	251662	251659
5	Streifen / Stecker Verbinder	251641	251651	-	-
6	Streifen / Draht Verbinder	-	-	-	251660
7	90° Streifen Verbinder	251643	251653	251663	251661



LED DOWNLIGHTS



BESTE WAHL



Slim V2

Ecowhite

Apollo V2

Hera

Leto

Triton

Forza V2

	Slim V2	Ecowhite	Apollo V2	Hera	Leto	Triton	Forza V2
WATT	12W - 24W	18W	6W - 25W	9W - 21W	8W - 15W	13,5W - 18,5W	28/32/36/40W
LUMEN	1200 - 2400	1400 - 1530	690 - 3060	800 - 2550	960 - 1800	1700 - 2400	Max 4300
LM/W	100	85	130	121	120	120	Max 117
IP / IK	IP44 / IK02	IP20 / IK05	IP20 / IK02	IP54 / IK02	IP44 / IK02	IP54 / IK03	IP20 / IK02
CUT SIZE	ø15cm - ø20cm	ø5,5-17,5cm	ø12cm - ø15cm ø20cm	ø12cm - ø15cm ø20cm	ø11,5cm ø14cm - ø18cm	ø15cm - ø17,5cm ø20cm - ø22,5cm	ø16cm
OPTIONEN	Dali & Notfal	×	Dali & Notfall auf Anfrage	×	×	×	Dali & Notfall auf Anfrage
SCHALTER	×	CCT	CCT & Watt	CCT	×	CCT & Watt	CCT & Watt
LEBENSDAUER L70	50,000h	30,000h	100,000h	30,000h	50,000h	50,000h	60,000h
GARANTIE	6 Jahre	4 Jahre	6 Jahre	4 Jahre	6 Jahre	6 Jahre	6 Jahre
PREIS/LEISTUNG	Besser	Gut	Beste Wahl	Gut	Besser	Besser	Besser
BESONDERHEIT	Dali & Notfal	CCT Schalter 4 Ringfarben	CCT Schalter & Watt Alu reflektor	CCT Schalter Schwarz ver- fügbar	Alu reflektor	CCT Schalter & Watt	CRI90 Schwarz ver- fügbar

09 LED DOWNLIGHTS

LED Downlight Slim V2

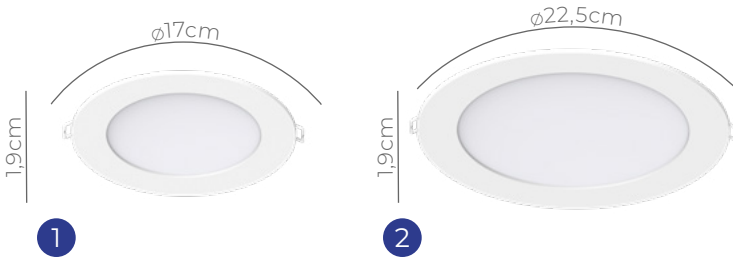

Extra flaches Downlight (19mm) · Flimmerfrei · 3000K oder 4000K · Ausschnittgröße: 15 oder 20cm · 6-Jahre Garantie · 120° · IP44 · IK02 · Klasse II · PF>0,9 · SPCC / Aluminium · Betriebstemperatur -20~45°C · CE / RoHS

<div style="display: flex; justify-content: space-between; align-items: center;"> <div style="display: flex; gap: 10px;"> CE RoHS -20~45°C IK02 IP44 CRI80 6 </div> <div style="display: flex; gap: 10px;"> W LM LM/W K 120° 50,000 170x19 </div> </div>												
#	Standard	BALI	3H	W	LM	LM/W	K	Beam	Life	Size		
1	12W 1200LM 3000K Ø15cm	238898	238904	249233	12	1200	100	3000	120°	50,000	Ø170x19	
	12W 1200LM 4000K Ø15cm	238899	238905		12	1200	100	4000		50,000	Ø170x19	
2	20W 2000LM 3000K Ø20cm	238900	238906	238918	20	2000	100	3000	120°	50,000	Ø225x19	
	20W 2000LM 4000K Ø20cm	238901	238907	238919	20	2000	100	4000		50,000	Ø225x19	
	24W 2400LM 3000K Ø20cm	238902	238908		24	2400	100	3000		50,000	Ø225x19	
	24W 2400LM 4000K Ø20cm	238903	238909		24	2400	100	4000		50,000	Ø225x19	

Weitere Informationen

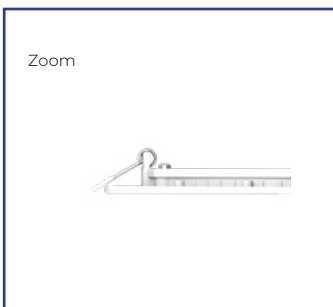

09 LED DOWNLIGHTS

LED Downlight Apollo V2



Ideal für die Installation in Fluren, Gemeinschaftsräumen in Büros, Hotels, Restaurants · Mögliche Optionen: mit Reflektor(UGR<19) · Notbeleuchtung · Flimmerfrei · 2CCT Schalter (3000K, 4000K) · Ausschnittgröße: 12, 15, 20cm · 6-Jahre Garantie · 60° · IP20 · IK02 · Klasse II · PF>0,8 · Aluminium / PC · Betriebstemperatur -20~40°C · CE / RoHS



Standard										
#	W	LM	LM/W	K	Beam	Life	Size	Material	Options	
1	6/9/12W 2CCT	Ø12cm	248329	6	720/760	124/130	3000/4000	60°	100,000	Ø145x92
				9	1060/1120	122/128	3000/4000			
				12	1400/1500	120/126	3000/4000			
2	6/9/12W 2CCT	Ø12cm Alu	248323	6	690/730	120/126	3000/4000	60°	100,000	Ø145x92
				9	1030/1090	118/124	3000/4000			
				12	1360/1460	116/122	3000/4000			
1	9/12/15W 2CCT	Ø15cm	248324	9	1080/1140	122/128	3000/4000	60°	100,000	Ø175x108
				12	1420/1520	120/126	3000/4000			
				15	1740/1860	118/124	3000/4000			
2	9/12/15W 2CCT	Ø15cm Alu	248325	9	1060/1120	118/124	3000/4000	60°	100,000	Ø175x108
				12	1380/1480	116/122	3000/4000			
				15	1680/1800	114/120	3000/4000			
1	15/20/25W 2CCT	Ø20cm	248326	15	1800/1920	122/128	3000/4000	60°	100,000	Ø220x140
				20	2380/2520	120/126	3000/4000			
				25	2900/3060	118/124	3000/4000			
2	15/20/25W 2CCT	Ø20cm Alu	248327	15	1740/1860	118/124	3000/4000	60°	100,000	Ø220x140
				20	2280/2420	116/122	3000/4000			
				25	2800/2960	114/120	3000/4000			
Zubehör										
3	Erweiterungsring Innen Ø12cm - Außen Ø16,7cm		243085							Ø167x10
	Erweiterungsring Innen Ø20cm - Außen Ø24cm		243086							Ø240x10

Weitere Informationen







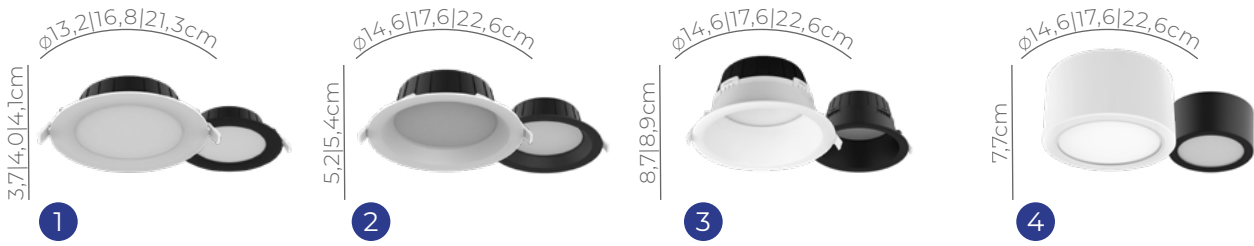

09 LED DOWNLIGHTS

LED Downlight Hera



Erhältlich in Weiß und Schwarz · Einbaumontage (medium oder tief) oder Oberflächenmontage · Für Badezimmer geeignet · 3CCT Schalter (2700K, 3000K, 4000K) · Ausschnittgröße: 12, 15, 20cm · 4-Jahre Garantie · 110° · IP54 · IK02 · Betriebstemperatur -20~40°C · CE / RoHS

      											
         											
Flach	○ ●										
1	9W 3CCT Ø12cm	252185	252184	9	800/900/900	89/100/100	2700/3000/4000	×	80°	30,000	Ø132x37
	9W 3CCT Ø15cm	252199	252198	15	1350/1500/1500	90/100/100	2700/3000/4000		80°	30,000	Ø168x40
	21W 3CCT Ø20cm	252187	252186	21	2200/2400/2400	105/114/105	2700/3000/4000		100°	30,000	Ø213x41
Einbau (medium)											
2	9W 3CCT Ø12cm	252189	252188	9	800/900/900	89/100/100	2700/3000/4000	×	80°	30,000	Ø146x52
	15W 3CCT Ø15cm	252191	252190	15	1350/1500/1500	90/100/100	2700/3000/4000		80°	30,000	Ø176x54
	21W 3CCT Ø20cm	252200	252192	21	2200/2400/2400	105/114/105	2700/3000/4000		100°	30,000	Ø226x54
Einbau (tief)											
3	9W 3CCT Ø12,5cm	252201	252193	9	800/900/900	89/100/100	2700/3000/4000	×	80°	30,000	Ø146x87
	15W 3CCT Ø15,5cm	252202	252194	15	1350/1500/1500	90/100/100	2700/3000/4000		80°	30,000	Ø176x89
	21W 3CCT Ø21cm	252203	252195	21	2200/2400/2400	105/114/105	2700/3000/4000		100°	30,000	Ø226x89
Oberflächenmontage											
4	15W 3CCT Ø15cm	252204	252196	15	1500/1700/1700	100/114/114	2700/3000/4000	×	100°	30,000	Ø150x77
	21W 3CCT Ø20cm	252205	252197	21	2300/2550/2550	110/121/121	2700/3000/4000		100°	30,000	Ø200x77

Weitere Informationen

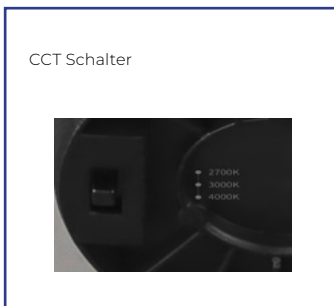

09 LED DOWNLIGHTS

LED Downlight Leto



Ideal für die Beleuchtung im Einzelhandel · Reflektor-Einbau-Downlight · 3000K oder 4000K · Ausschnittgröße: 13,3, 16,5 oder 20,5cm · 6-Jahre Garantie · 70° · CRI90 · IP20 · IK02 · Betriebstemperatur -20~40°C · CE / RoHS



#



8W 960LM 930 Ø11,5cm	252802	8	960	120	3000	×	70°	80,000	ø133x70
8W 960LM 940 Ø11,5cm	252803	8	960	120	4000		70°	80,000	ø133x70
12W 1440LM 930 Ø14cm	252804	12	1440	120	3000		70°	80,000	ø165x86
12W 1440LM 940 Ø14cm	252805	12	1440	120	4000		70°	80,000	ø165x86
15W 1800LM 930 Ø18cm	252806	15	1800	120	3000		70°	80,000	ø205x98
15W 1800LM 940 Ø18cm	252807	15	1800	120	4000		70°	80,000	ø205x98

09 LED DOWNLIGHTS

LED Downlight Triton

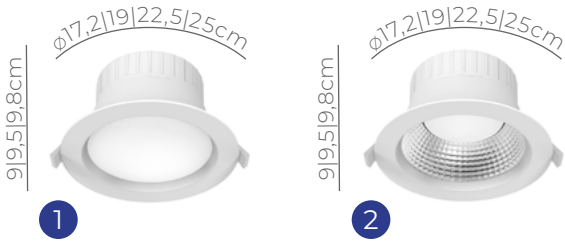

Mögliche Optionen: mit Reflektor (100°) · Wattschalter: 13,5/18,5W · 2CCT Schalter (3000K, 4000K) · Ausschnittgröße: 15, 17,5, 20, 22,5cm · 6-Jahre Garantie · 90° · IP54 · IK03 · Betriebstemperatur -20~40°C · CE / RoHS

      										
         										
Diffusor										
1	13,5/18,5 2CCT Ø15cm	250425	13,5/18,5	1800/2400	120	3000/4000	×	90°	90,000	Ø172x90
	13,5/18,5 2CCT Ø17,5cm	250763	13,5/18,5	1800/2400	120	3000/4000		90°	90,000	Ø190x95
	13,5/18,5 2CCT Ø20cm	250429	13,5/18,5	1800/2400	120	3000/4000		90°	90,000	Ø225x98
	13,5/18,5 2CCT Ø22,5cm	250765	13,5/18,5	1800/2400	120	3000/4000		90°	90,000	Ø250x98
Reflektor										
2	13,5/18,5 2CCT Ø15cm	250424	13,5/18,5	1700/2300	120	3000/4000	×	100°	90,000	Ø172x90
	13,5/18,5 2CCT Ø17,5cm	250426	13,5/18,5	1700/2300	120	3000/4000		100°	90,000	Ø190x95
	13,5/18,5 2CCT Ø20cm	250764	13,5/18,5	1700/2300	120	3000/4000		100°	90,000	Ø225x98
	13,5/18,5 2CCT Ø22,5cm	250430	13,5/18,5	1700/2300	120	3000/4000		100°	90,000	Ø250x98

Weitere Informationen

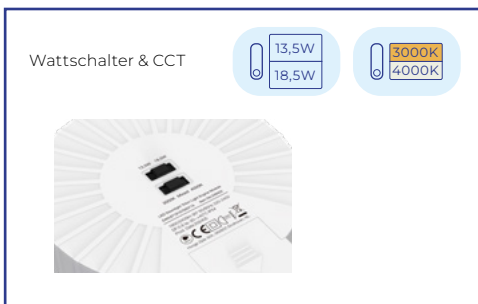

09 LED DOWNLIGHTS

LED Downlight Forza V2

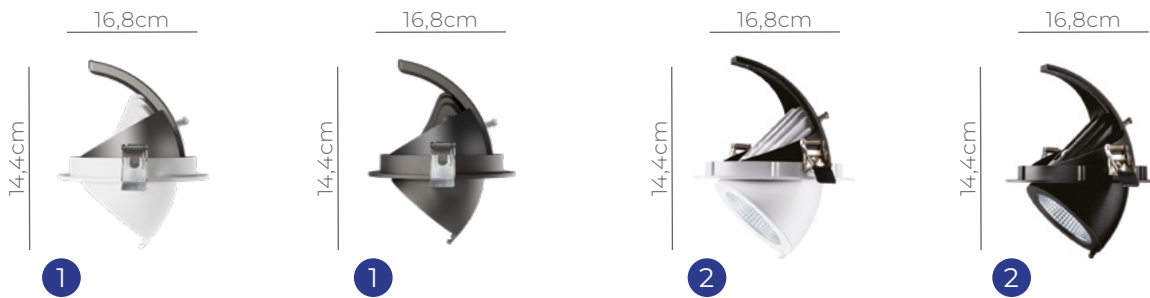

Ideal für die Ladenbeleuchtung · 45° schwenkbar, 355° drehbar · Erhältlich in Weiß und Schwarz · Wattochalter · CCT Schalter · Dali und Notfall auf Anfrage verfügbar · Ausschnittgröße: 16,8cm · 6-Jahre Garantie · UGR<19 · 36° · IP20 · IK02 · Klasse II · PF>0,9 · Aluminium · Betriebstemperatur -20~45°C · CE / RoHS



		#	W	LM	LM/W	K					
Forza V2		<input type="radio"/>	<input type="radio"/>								
1	28/32/36/40W 3CCT 36° Ø16,8cm	255939 255940	28	3000/3300/3200	107/117/114	3000/4000/5700	×	36°	60,000	168X144	
			32	3300/3700/3700	103/115/115	3000/4000/5700					
			36	3700/4100/4000	102/113/111	3000/4000/5700					
			40	3900/4500/4300	98/113/108	3000/4000/5700					
Forza V1											
2	35W 3100LM 930 36° Ø16,8cm	245302 245304	35	3100	90	3000	×	36°	50,000	168X144	
	35W 3200LM 940 36° Ø16,8cm	245303	35	3200	92	4000					36°

Weitere Informationen







NOTBELEUCHTUNG

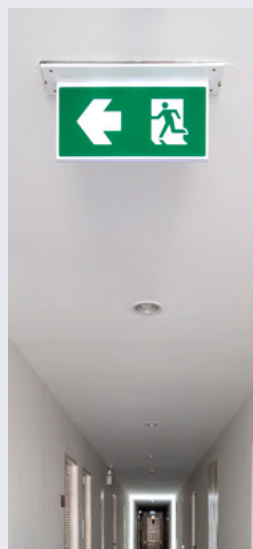

BESTE WAHL



Notbeleuchtung Autotest



Notbeleuchtung Bulkhead



Notausgangsschild

WATT	3,5W	8,5W	3,5W
IP / IK	IP20 / IK06	IP20 / IK06	IP40 / IK04
OPTIONEN	Notmodul & Sensor	Notmodul	Notmodul
SCHALTER	×	×	×
LEBENSDAUER L70	50,000h	30,000h	30,000h
GARANTIE	3 Jahre	2 Jahre	3 Jahre
PREIS/LEISTUNG	Beste Wahl	Besser	Besser

10 NOTBELEUCHTUNG

LED Notbeleuchtung Autotest

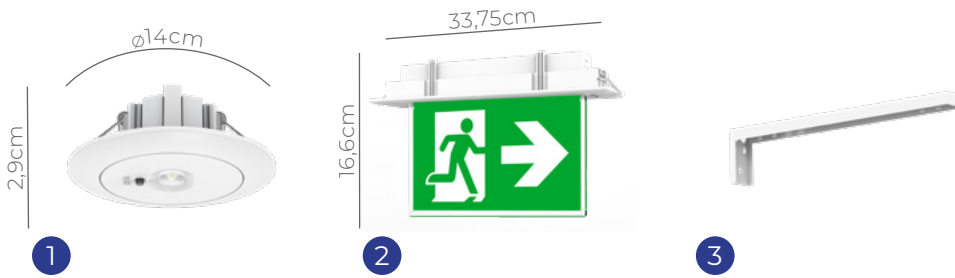

1	Notbeleuchtung Spot Weiß 3W 240lm - 850K Kaltweiß 3H - Ø14cm	245469	3	5000	3H	24H	1500mAh LiFePO4 6.4V	50,000	Ø140x29,5
2	Notausgangsschild 1W 20lm - 860 Tageslichtweiß 3H - incl. 4 directions	245470	3.5	6000	3H	24H	1500mAh LiFePO4 3.2V	50,000	337,5x166x43
3	Seitliche Halterung für Noxion LED Notausgangsschild	245471							

Weitere Informationen

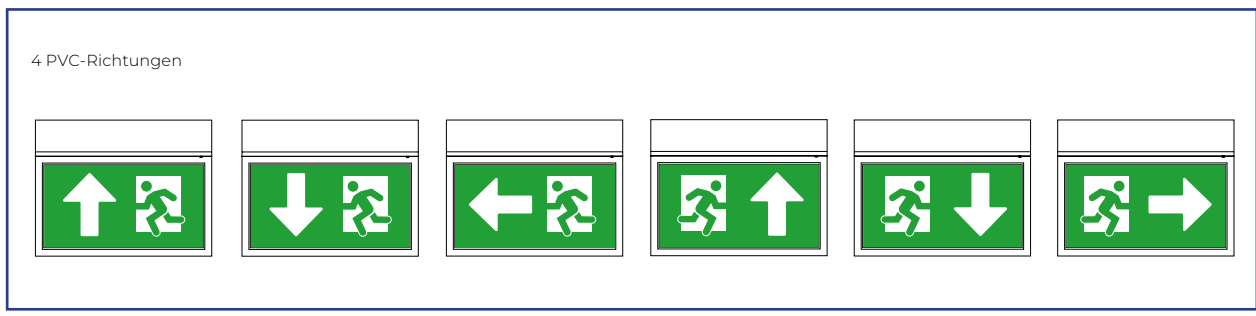

10 NOTBELEUCHTUNG

LED Notbeleuchtung Bulkhead



1	Bulkhead Weiß 8.5W 500lm - 865 Tageslichtweiß 3 Stunden - inkl. 4 Richtungen	245467	8.5	6500	3H	24H	Ni-Cd SC3.6V 2Ah	30,000	352x110x68
2	Einbaurahmen für Noxion LEDNotbeleuchtung Bulkhead	245468							

Weitere Informationen

4 PVC-Richtungen

10 NOTBELEUCHTUNG

LED Notausgangsschild



1	Notbeleuchtung Wand/Deckenmontage 3.5W 3H inkl. 4 Wegweiser aus PVC	239389	3,5	6000	3H	24H	Ni-Mh 3.6V 0.7Ah	30,000	335x45x245
2	Einbau-Rahmen	239390							
3	Aufhängungsset 2m	239391							

Weitere Informationen

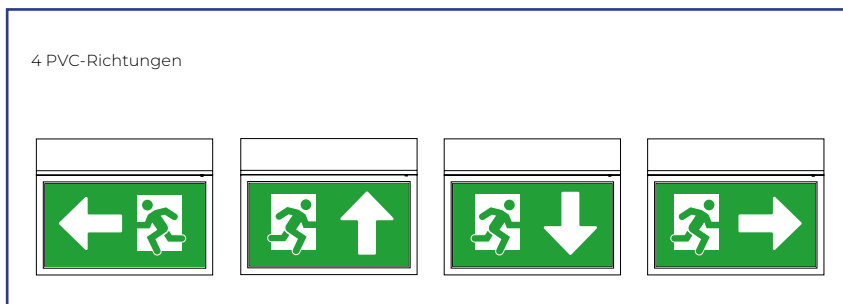





LED SCHIENENSTRAHLER



BESTE WAHL



Delta Pro



Ecowhite



Schienenstrahl | GU10

WATT	20/30/40W	10 - 30W	-
LUMEN	Max 4900	840 - 3210	-
LM/W	Max 125	107	-
IP / IK	IP20 / IK07	IP20 / IK07	IP20 / IK07
TREIBER	Externer Treiber KGP	Interner Treiber KGP	-
OPTIONEN	Universaladapter	Universaladapter	-
SCHALTER	CCT Schalter & Watt	×	-
LEBENSDAUER L70	60,000h	50,000h	-
GARANTIE	6 Jahre	4 Jahre	4 Jahre
PREIS/LEISTUNG	Beste Wahl	Gut	Gut
BESONDERHEIT	CCT Schalter & Watt Externer Treiber	Interner Treiber	GU10-Fassung

LED Schienenstrahler Delta Pro



Ersatz für CDM-Leuchten · Universeller Globaladapter für die meisten Standardschiensysteme · KGP externer Treiber
 · Phase 0, 1, 2 und 3 · 90° schwenkbar und 350° drehbar · Erhältlich in Weiß und Schwarz · Wattschalter · 3CCT Schalter
 (3000K, 4000K, 5700K) · CRI90 · 6-Jahre Garantie · UGR<19 · 36° · IP20 · IK06 · Klasse II · PF>0,9 · Betriebstemperatur
 -20~45°C · CE / RoHS



#	W	LM	LM/W	K	Rotation	Tilt	Timer	Dimensions (mm)			
									W	LM	LM/W
1	20/30/40W 3CCT 36°	252898	252899	20	2300/2500/2500	115/125/125	3000/4000/5700	×	36°	60,000	ø100x190
				30	3400/3700/3600	113/123/120	3000/4000/5700				
				40	4400/4900/4700	110/123/118	3000/4000/5700				
Zubehör											
2	Reflektor 24°	252916									
2	Reflektor 60°	252917									
3	Honeycomb	252918									

Weitere Informationen

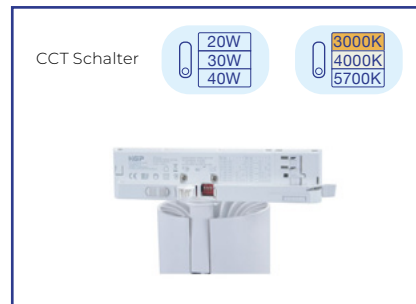

LED Schienenstrahler Ecowhite



Ersatz für CDM-Leuchten · Universeller Globaladapter für die meisten Standardschiensysteme · KGP eingebauter Treiber · Phase 0, 1, 2 und 3 · 90° neigbar und 350° drehbar · Erhältlich in Weiß und Schwarz · 10W, 20W & 30W · 3000K oder 4000K · CRI90 · 4-Jahre Garantie · UGR<19 · 36° · IP20 · IK07 · Klasse II · PF>0,9 · Betriebstemperatur -20~45°C · CE / RoHS



		#	W	LM	LM/W	K					
		○ ●					⊗				
1	10W 840LM 930 36°	252901 252900	10	840	84	3000	⊗	36°	50,000	ø55x205	
	10W 920LM 940 36°	252903 252902	10	920	92	4000		36°	50,000	ø55x205	
2	20W 1970LM 930 36°	252905 252904	20	1970	99	3000		36°	50,000	ø74x238	
	20W 2060LM 940 36°	252907 252906	20	2060	103	4000		36°	50,000	ø74x238	
3	30W 2960LM 930 36°	252909 252908	30	2960	99	3000		36°	50,000	ø90x253	
	30W 3210LM 940 36°	252911 252910	30	3210	107	4000		36°	50,000	ø90x253	

Weitere Informationen

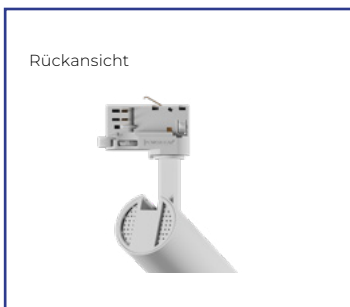

Pendelleuchte & Schienenstrahler | GU10 Fassung



GU10-Fassung · Ersatz für CDM-Leuchten · Universeller globaler Adapter, passend für die meisten Standard-Schiensysteme, um 90° neigbar und um 350° drehbar · Erhältlich in Weiß und Schwarz · 4-Jahre Garantie · 36° · IP20 · IK07 · Klasse II · PF>0,9 · Betriebstemperatur -20~45°C · CE / RoHS



GU10-Spots sind auf Seite 84 verfügbar.



Pendelleuchte | GU10



1	3-Phasen Geeignet GU10 Pendelleuchte	252913	252912	×	ø55x1150
Schienenstrahler GU10					
2	3-Phasen Geeignet GU10 Schienenstrahler	252915	252914	×	ø55x193





LED EINBAUSTRAHLER

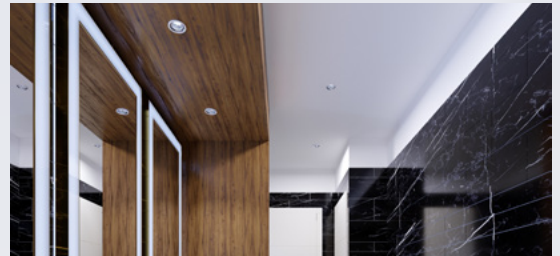

BESTE WAHL



Spot Slim



Ares



LED-integrierter Spot



Einbaustrahler für GU10-Lampen

	Spot Slim	Ares	LED-integrierter Spot	Einbaustrahler für GU10-Lampen
WATT	6W	6W	8W	-
LUMEN	520 - 550	480 - 540	585 - 700	-
LM/W	93	90	80	-
IP / IK	IP54 / IK02	IP65 / IK02	IP44-65 / IK02	IP20 / IK02
DIMMBAR	✓	✓	✓	-
OPTIONEN	-	Feuerfest	Feuerfest	-
SCHALTER	CCT	CCT	✗	✗
LEBENSDAUER L70	50,000h	50,000h	50,000h	-
GARANTIE	6 Jahre	6 Jahre	6 Jahre	4 Jahre
PREIS/LEISTUNG	Besser	Beste Wahl	Besser	Besser
BESONDERHEIT	Schalter 2 CCT Extraflaches Design	Schalter 3 CCT Feuerfest Anpassbar	Zahlreiche Modelle Verschiedene Farben verfügbar	Zahlreiche Modelle Verschiedene Farben verfügbar

12 LED EINBAUSTRAHLER

Schwenkbarer Slim LED Spot



Sehr schlanke Spots · Erhältlich in Weiß, Schwarz und Aluminium · 6W · 2700K, 3000K, 4000K oder 2CCT (2000K / 3000K) · CRI90 · Ausschnittgröße: 8,5cm · 6-Jahre Garantie · Dimmbar · 60° · IP54 · IK02 · Aluminium / Polycarbonat · Betriebstemperatur -20~40°C · CE / RoHS

				CE		RoHS		-20~40°C		IK02		IP54		CRI90		6			
#				W		LM		LM/W		K		◀▶		⌵		🕒		📏 (mm)	
				○		●		●											
6W 520LM 927	245688	245689	245690	6	520	90	2700	✓	60°	50,000	Ø85x28								
6W 550LM 930	244924	244925		6	550	93	3000		60°	50,000	Ø85x28								
6W 550LM 940	245682	245683		6	550	93	4000		60°	50,000	Ø85x28								
6W 2CCT 920-930	245685			6	350	60	2000/3000		60°	50,000	Ø85x28								

Weitere Informationen



12

LED EINBAUSTRAHLER

LED Spot Ares



Viele verschiedene Designs und Versionen für jede Installation · Brandschutzpunkte verfügbar · Kann mit verschiedenen Ringfarben konfiguriert werden · 6W · Schalter 3CCT (2700, 3000, 4000K) · Ausschnittgröße: 6,8cm · 6-Jahre Garantie · Dimmbar · 38° · IP65 · IK02 · Klasse II · PF>0,9 · Aluminium · Betriebstemperatur -20~45°C · CE / RoHS



	#	W	LM	LM/W	K						
LED integriert	<input type="radio"/>										
Ares Fest 6W 3CCT	253995 253992	6	480/520/540	80/86/90	2700/3000/4000	38°	×	✓	50,000	Ø68x40	
Ares Tief 6W 3CCT	254001 254005	6	480/520/540	80/86/90	2700/3000/4000	38°	×	✓	50,000	Ø68x47	
Ares Schwenkbar 6W 3CCT	253998 253997	6	480/520/540	80/86/90	2700/3000/4000	38°	25°	✓	50,000	Ø68x40	
Ares Fest Fire-rated 6W 3CCT	254018 254021	6	480/520/540	80/86/90	2700/3000/4000	38°	×	✓	50,000	Ø68x40	
Ares Schwenkbar Fire-rated 6W 3CCT	254015 254017	6	480/520/540	80/86/90	2700/3000/4000	38°	25°	✓	50,000	Ø68x40	
Spot Nachrüstung GU10											
Ares Fest	253996 253994						×		Ø80mm	Ø68x40	
Ares Tief	254007 254012						×		Ø73mm	Ø68x47	
Ares Schwenkbar	254000						25°		Ø70mm	Ø68x40	

12

LED EINBAUSTRAHLER

Integrierte LED Spots



Viele verschiedene Designs & Looks für jede Installation · Erhältlich in Weiß und Aluminium · 8W · 2700K · Ausschnittgröße: 70, 72, 73, 74, 80, 83 oder 92mm · 6-Jahre Garantie · UGR<15 · Dimmbar · 33°/37° · IP44/IP54/IP65 · IK02 · Klasse II · PF>0,9 · Aluminium / Polycarbonat · Betriebstemperatur -20~45°C · CE / RoHS



☰		#	W	LM	LM/W	K	☰	☰	☰	☰	☰	☰
○ ●												

1	Starlight IP54	224361	8	610	70	2700	37°	✗	✓	Ø80mm	85x90
2	Ember IP65 feuerfest	244600 244611	8	585	70	2700	34°	✗	✓	Ø73mm	80x57
3	H2O IP65 feuerfest	244603	8	585	70	2700	34°	✗	✓	Ø70mm	85x70
4	Hydro IP65 feuerfest	244612	8	585	70	2700	34°	30°	✓	Ø83mm	95x63
5	Gimax IP44	224358	8	610	72	2700	33°	✗	✓	Ø74mm	80x57
6	Aqua IP65 feuerfest	242001	8	585	70	2700	33°	30°	✓	Ø92mm	100x64
7	Forseti IP44	224357	8	600	72	2700	37°	✗	✓	Ø72mm	80x75

Einbaustrahler Retrofit GU10



Einbaustrahler für GU10-Lampen · Viele verschiedene Designs, Formen und Farben · GU10-Fassung mit 18 cm Kabel im Lieferumfang enthalten · Max. Leistung 50 W · Hochwertiges Produkt mit starken Clips für perfekten Sitz in der Decke · Erhältlich in Weiß, Schwarz und Aluminium · 4-Jahre Garantie · IP20 · Aluminium



GU10-Spots sind auf Seite 84 verfügbar.



		○	●	●			
1	Boxi	220658	220657	232027	40°	Ø80mm	92x25
2	Drome	220652	220651	232025	40°	Ø69mm	82x23
3	Logic	220655	220654	232026	40°	Ø80mm	92x25
4	Vision	220649	220648	232024	40°	Ø69mm	82x23
5	D-Flex	220646			40°	Ø70mm	82x24
6	Flox	220640		232022	40°	Ø70mm	82x24
7	D-Round	220644		232023	×	Ø70mm	82x35
8	D-Deep	220645			×	Ø70mm	82x35
9	Fix	220638			×	Ø70mm	82x24
10	Rondo	220647			×	Ø70mm	90x78



LED STRAHLER



	GU10 PerfectColor	GU10 Standard	GU4 PerfectColor	GU5.3 PerfectColor	GU5.3 Standard	G53 AR111	GU10 Pro AR111
WATT	2,6W - 4W	2,4W - 5,5W	1,8W - 4,5W	3W - 7,5W	2,5W - 7,8W	7,2W - 11,7W	12W
LUMEN	260 - 380	230 - 560	184 - 345	230 - 621	230 - 730	450 - 880	600 - 850
LM/W	91	113	84	83	111	78	56
CRI	97	80	90	90	80	97	90
DIMMBAR	✓	✓	✓	✓	✓	✓	✓
LEBENSDAUER L70	15,000 - 25,000h	25,000h	25,000h	25,000h	15,000 - 25,000h	40,000h	45,000h
GARANTIE	5 Jahre	3 Jahre	5 Jahre	5 Jahre	3 Jahre	5 Jahre	5 Jahre

13 LED STRAHLER

LED GU10 PerfectColor



1



2



3

-20~40°C

CRI80

CRI97

5

	#	W	= W	LM	LM/W	K						
36°												
1	2.6W 230LM 922-927	242054	2,6	35	260	86	2200/2700	F	✓	36°	15,000	Ø50x52
	3W 230LM 927	241672	3	35	260	77	2700					Ø50x52
	3.8W 345LM 922-927	241959	3,8	50	380	91	2200/2700					Ø50x54
	4W 345LM 927	241955	4	50	380	86	2700					Ø50x54
	4W 345LM 930	242050	4	50	380	86	3000					Ø50x54
	4W 345LM 940	243440	4	50	380	86	4000					Ø50x54
	6.7W 575LM 927	250683	6,7	80	575	86	2700					Ø50x53
	6.7W 575LM 930	250684	6,7	80	575	86	3000					Ø50x53
	6.7W 575LM 940	250685	6,7	80	575	86	4000					Ø50x53
60°												
2	3W 230LM 927	242051	3	35	260	77	2700	F	✓	60°	15,000	Ø50x52
	4W 345LM 927	241645	4	50	380	86	2700					Ø50x54
	4W 345LM 930	241646	4	50	380	86	3000					Ø50x54
	4W 345LM 940	241647	4	50	380	86	4000					Ø50x54
	6.7W 575LM 927	250686	6,7	80	575	86	2700					Ø50x53
	6.7W 575LM 930	250687	6,7	80	575	86	3000					Ø50x53
120°												
3	6.7W 650LM 827	250689	6,7	51	650	97	2700	F	✓	120°	25,000	Ø50x55
	6.7W 650LM 830	250690	6,7	51	650	97	3000					
	6.7W 650LM 840	250691	6,7	51	650	97	4000					

13 LED STRAHLER

LED GU10 Standard



1

2

3

-20~40°C

CRI80

3

	#	W	= W	LM	LM/W	K									
36°															
1	2.4W 230LM 827	242299 254656	2,4	35	230	96	2700	E	X	36°	25,000	Ø50x54			
	2.4W 230LM 830	242300 254657	2,4	35	230	96	3000	E							
2	3W 230LM 827	241957	3	35	230	77	2700	F	✓					Ø50x54	
	3W 230LM 830	243403	3	35	230	77	3000	F						Ø50x54	
1	3.6W 345LM 830	244565	3	35	230	77	4000	F	X					Ø50x54	
	3.6W 345LM 840	254658	3,6	50	345	96	3000	E						Ø50x54	
2	4W 345LM 827	242052	4	50	345	86	2700	F	✓					Ø50x54	
	4W 345LM 830	241648	4	50	345	86	3000	F						Ø50x54	
	4W 345LM 840	244564	4	50	345	86	4000	F						Ø50x54	
2	4.8W 450LM 827	242053	4,8	65	450	94	2700	E	X					Ø50x54	
	4.8W 450LM 840	242298	4,8	65	450	94	4000	F						Ø50x54	
	5.5W 560LM 827	250692	5,5	78	560	102	2700	E						Ø50x53	
	5.5W 560LM 830	241958	5,5	78	560	102	3000	E				Ø50x54			
60°															
2	5.5W 560LM 830	250694	5,5	78	560	102	3000	E	X	60°	25,000	Ø50x53			
	5.5W 560LM 840	250695	5,5	78	560	102	4000	E							
120°															
3	5.5W 620LM 830	250697	5,5	50	620	112	3000	E	X	120°	25,000	Ø50x55			
	5.5W 620LM 840	250698	5,5	50	620	112	4000	E							

13 LED STRAHLER

LED GU4 PerfectColor



#
W
= W
LM
LM/W
K

PerfectColor 36°												
2.8W 184LM 927	250437 254684	2,8	20	184	72	2700	G	×	36°	25,000	Ø35x38	
2.8W 184LM 927	254714	2,8	20	184	72	2700		✓				
4.5W 345LM 927	250438 254685	4,5	35	345	84	2700		×				
4.5W 345LM 927	250436 254713	4,5	35	345	84	2700		✓				
Standard 36° (3 Jahre Garantie)												
1.8W 184LM 827	250680	1,8	20	184	102	2700	E	×	36°	25,000	Ø35x46	

13 LED STRAHLER

LED GU5.3 PerfectColor



	#	W	= W	LM	LM/W	K						
36°												
3W 230LM 927	251855	3	20	230	77	2700	F	✓	36°	25,000	Ø50x46,5	
3W 230LM 930	251856	3	20	230	77	3000	F					
4.5W 345LM 927	251859	4,5	35	345	77	2700	F					
4.5W 345LM 930	251860	4,5	35	345	77	3000	F					
4.5W 345LM 940	251861	4,5	35	345	77	4000	F					
7.5W 621LM 927	251867	7,5	50	621	83	2700	F					
7.5W 621LM 930	251868	7,5	50	621	83	3000	F					
60°												
4.5W 345LM 927	251862	4,5	35	345	77	2700	F	✓	60°	25,000	Ø50x46,5	
4.5W 345LM 930	251863	4,5	35	345	77	3000	F					
7.5W 621LM 927	251870	7,5	50	621	83	2700	F					
7.5W 621LM 930	251871	7,5	50	621	83	3000	F					
7.5W 621LM 940	251872	7,5	50	621	83	4000	F					

13 LED STRAHLER

LED GU5.3 MR16



🌡️ -20~40°C

CR180

3

#

W

= W

LM

LM/W

K



36°

#	W	= W	LM	LM/W	K	📄	🔄	🏠	🕒	💡 (mm)	
2.5W 230LM 827	242055	2,5	20	230	92	2700	F	✗	36°	15,000	Ø50x46,5
2.9W 230LM 827	251853	2,9	20	230	79	2700	F	✗		25,000	Ø50x46,5
3.4W 345LM 840	244207	3,4	35	345	101	4000	E	✗		15,000	Ø50x44
4W 345LM 827	242056	4	35	345	86	2700	F	✗		15,000	Ø50x46,5
4.4W 345LM 827	251857	4,4	35	345	78	2700	F	✗		25,000	Ø50x46,5
4.4W 345LM 830	251873	4,4	35	345	78	3000	F	✗		25,000	Ø50x46,5
4.4W 345LM 840	242303	4,4	35	345	78	4000	F	✓		25,000	Ø50x46,5
6.1W 621LM 830	251864	6,1	50	621	102	3000	E	✗		25,000	Ø50x48
6.1W 621LM 830	244206 251865	6,1	50	621	102	3000	E	✗		15,000	Ø50x44
6.1W 621LM 840	244205 251866	6,1	50	621	102	4000	E	✗		15,000	Ø50x44
7.5W 621LM 827	244369 254667	7,5	50	621	83	2700	F	✓		25,000	Ø50x44
7.5W 621LM 830	242306 254663	7,5	50	621	83	3000	F	✓		25,000	Ø50x44

60°

4.4W 345LM 827	242304	4,4	35	345	78	2700	F	✓	60°	25,000	Ø50x44
4.4W 345LM 830	242305 254662	4,4	35	345	78	3000	F				
7.5W 621LM 827	244368 254666	7,5	50	621	83	2700	F				
7.5W 621LM 830	242307 254664	7,5	50	621	83	3000	F				
7.5W 621LM 840	242308 254665	7,5	50	621	83	4000	F				

13 LED STRAHLER

LED G53 / GU10 AR111



-20~40°C
 CRI97
 5

		#	W	= W	LM	LM/W	K					
G53 24°												
1	7.2W 450LM 918-927	244361 249460	7,2	50	450	63	1800/ 2700	G	✓	24°	40,000	Ø110.7x55
	7.4W 450LM 930	242290 254676	7,4	50	450	61	3000	G				
	11.7W 800LM 927	249465 254679	11,7	75	800	75	2700	G				
	11.7W 800LM 930	249466 254680	11,7	75	800	75	3000	G				
G53 40°												
2	7.2W 450LM 918-927	244362 254675	7,2	50	450	68	1800/ 2700	G	✓	40°	40,000	Ø110.7x55
	7.4W 450LM 927	242291 254677	7,4	50	450	61	2700	G				
	7.4W 450LM 930	242292 254678	7,4	50	450	61	3000	G				
	11.7W 800LM 927	249467 254681	11,7	75	800	75	2700	G				
	11.7W 800LM 930	248924 254670	11,7	75	800	75	3000	G				
GU10 40°												
3	12W 600LM 927	242314	12	50	600	50	2700	E	✓	40°	45,000	Ø111x93
	12W 600LM 930	242315	12	50	600	50	3000	E				Ø111x93
	15W 850LM 927	242316	15	75	850	56	2700	E				Ø111x104
	15W 850LM 930	242317	15	75	850	56	3000	E				Ø111x104



LED LAMPEN



Classic

Filament
Classic

TSlim & Stick



Lustre

Filament
Lustre

Kerze

	Classic	Filament Classic	TSlim & Stick	Lustre	Filament Lustre	Kerze
WATT	5,5W - 14W	4,5W - 12W	7W - 9,5W	2,5W - 5,5W	1,4W - 4,5W	2,5W - 4,5W
LUMEN	470 - 1521	470 - 1521	806 - 1050	136 - 470	136 - 470	250 - 470
LM/W	121	145	115	104	104	104
CRI	80 - 90	80	80	80	80	80
SOCKEL	E27	E27	E27	E14 - E27	E14 - E27	E14
FORM	A60 - A65	A60 - ST64 - G95 - G125	T32 - T37	P45	P45	B35 - BA35
DIMMBAR	✓	✓	✓	✓	✓	✓
LEBENSDAUER L70	15,000h	15,000h	15,000h	15,000h - 25,000h	15,000h	15,000h
GARANTIE	3 Jahre	3 Jahre	3 Jahre	3 Jahre	3 Jahre	3 Jahre

14

LED LAMPEN

LED Lampen Lucent Classic



-20~40°C

CRI80

CRI90

3

	#	W	= W	LM	LM/W	K							
PRO A60 E27													
1	5.5W 470LM 827	244551	5,5	40	470	94	2700	F	✓	180°	15,000	Ø60x112	
	9W 806LM 922-927	241909	9	60	806	90	2200/ 2700	F		180°	15,000	Ø60x115	
2	12.5W 1521LM 827	249456 254672	12,5	100	1521	121	2700	E	✗	220°	15,000	Ø60x115	
	12.5W 1521LM 840	254673	12,5	100	1521	121	4000	E		220°	25,000	Ø60x115	
A60 E27													
3	4.9W 470LM 827	241938	4,9	40	470	98	2700	F	✗	180°	15,000	Ø60x108	
	4.9W 470LM 830	241939	4,9	40	470	98	3000	F		180°	15,000	Ø60x108	
	4.9W 470LM 840	242030	4,9	40	470	98	4000	F		180°	15,000	Ø60x108	
	8W 806LM 827	242283	8	60	806	101	2700	F		180°	15,000	Ø60x108	
	8W 806LM 840	241940	8	60	806	101	4000	F		180°	15,000	Ø60x108	
1	8.5W 806LM 827	242285	8,5	60	806	95	2700	F	✓	150°	15,000	Ø60x112	
	8.5W 806LM 830	242031	8,5	60	806	95	3000	F		✗	180°	15,000	Ø60x108
	9.5W 1055LM 827	241941	9,5	75	1055	111	2700	E			180°	15,000	Ø60x109
	9.5W 1055LM 830	241942	9,5	75	1055	111	3000	E			180°	15,000	Ø60x109
	9.5W 1055LM 840	241943	9,5	75	1055	111	4000	E			180°	15,000	Ø60x109
4	11W 1055LM 827	241944	11	75	1055	96	2700	F	✓		180°	15,000	Ø60x120
	13W 1521LM 830	242284	13	100	1521	117	3000	E		✗	180°	15,000	Ø60x120
A65 E27													
5	14W 1521LM 827	241945	14	100	1521	109	2700	F	✓	150°	15,000	Ø60x120	

14 LED LAMPEN

LED Lampen Lucent Filament



🌡️ -20~40°C

CRI80

3

🔍	#	W	= W	LM	LM/W	K	📄	🔄	🏠	🕒	📏 (mm)	
A60 E27 FILAMENT												
1	4.5W 470LM 822-827	242057	4,5	40	470	104	2200/2700	F	✗	360°	15,000	Ø60x104
	4.5W 470LM 827	241948	4,5	40	470	104	2700	F		360°	15,000	Ø60x104
	4.5W 470LM 840	244561	4,5	40	470	104	4000	E	✓	360°	15,000	Ø60x104
	7W 806LM 822-827	242058	7	60	806	115	2200/2700	E		360°	15,000	Ø60x104
	7W 806LM 827	241949	7	60	806	115	2700	E		360°	15,000	Ø60x104
	7W 806LM 827	241591	7	60	806	115	2700	E	✗	360°	15,000	Ø60x104
	7W 806LM 840	244560	7	60	806	115	4000	E	✗	360°	15,000	Ø60x104
2	7W 630LM 822 Amber	254639	7	60	630	90	2200	F	✓	320°	15,000	Ø60x108
	7.2W 630LM 822 Amber	240926	7,2	50	630	88	2200	F		320°	15,000	Ø60x108
1	8.5W 1055LM 827	242286	8,5	75	1055	124	2700	E	✗	360°	15,000	Ø60x104
	9W 1055LM 827	244559	9	75	1055	117	2700	E	✓	360°	15,000	Ø60x104
	10.5W 1521LM 827	248346	10,5	100	1521	145	2700	D	✗	330°	15,000	Ø60x108
	11W 1521LM 827	254671	11	100	1521	138	2700	D	✓	320°	15,000	Ø60x108
	11.2W 1521LM 827	249455	11,2	100	1521	135	2700	D		300°	15,000	Ø60x104
ST64 E27 FILAMENT												
3	4W 470LM 827	242281	4	40	470	118	2700	E	✗	300°	15,000	Ø64x141
4	7W 630LM 822 Amber	254641	7	50	630	90	2200	F	✓	320°	15,000	Ø64x141
	7.2W 630LM 822 Amber	240929	7,2	50	630	88	2200	F		320°	15,000	Ø64x141
G95 E27 FILAMENT												
5	7W 806LM 827	249458	7	60	806	115	2700	E	✓	360°	15,000	Ø95x140
	7W 806LM 827	254645	7	60	806	115	2700	E	✗	330°	15,000	Ø95x140
G125 E27 FILAMENT												
6	7W 630LM 822 Amber	254642	7	50	630	90	2200	F	✓	320°	15,000	Ø125x178
	7.2W 630LM 822 Amber	240930	7,2	50	630	88	2200	F		320°	15,000	Ø125x175

14 LED LAMPEN

LED Lampen Lucent Classic TSlim & Stick



-20~40°C CRI80 3

		#	W	= W	LM	LM/W	K					
T32 E27												
1	7W 806LM 827	250754 254686	7	60	806	115	2700	E	✓	320°	15,000	Ø32x80
T37 E27												
2	9.5W 950LM 830	250681	9,5	68	950	100	3000	F	✗	200°	15,000	Ø38x111
	9.5W 1050LM 840	250682	9,5	75	1050	111	4000	F		200°	15,000	Ø38x111

14 LED LAMPEN

LED Lampen Lucent Classic Lustre



-20~40°C
 CRI80
 3

	#	W	= W	LM	LM/W	K							
P45 E27													
1	2.5W 250LM 827	241590	2,5	25	250	100	2700	F	×	150°	15,000	Ø45x77	
2	5.5W 470LM 822-827	254715	5,5	40	470	86	2200/ 2700	F	✓	240°	25,000	Ø45x85	
P45 E14													
3	4.5W 470LM 827	241947	4,5	40	470	104	2700	F	×	150°	15,000	Ø45x80	
	5.5W 470LM 822-827	240936 254716	5,5	40	470	86	2200/ 2700	F	✓	240°	25,000	Ø45x86	

14 LED LAMPEN

LED Lampen Lucent Lustre Filament



-20~40°C CRI80 3

		#	W	= W	LM	LM/W	K						
P45 E27													
1	1.4W 136LM 827	244558	1,4	15	136	97	2700	F	×	360°	15,000	Ø45x78	
2	2.5W 250LM 827	242029	2,5	25	250	100	2700	F	×	360°	15,000	Ø45x78	
		241946											
	2.5W 250LM 827	242282							✓				
4	4.1W 350LM 822 Amber	240928	4,1	32	350	85	2200	F	✓	320°	15,000	Ø45x82	
3	4.5W 470LM 827	242289	4,5	40	470	104	2700	F	×	360°	15,000	Ø45x78	
		241950											
	4.5W 470LM 827	241950							✓				
4	4.5W 400LM 822 Amber		4,5	40	400	89	2200	F	✓	320°	15,000	Ø45x78	
P45 E14													
5	2.5W 250LM 827	242287	2,5	25	250	100	2700	F	×	360°	15,000	Ø45x80	
		241589											
	2.5W 250LM 827	241589							✓				
6	4.5W 470LM 827	242288	4,5	40	470	104	2700	F	×	360°	15,000	Ø45x80	
		244204											
	4.5W 470LM 827	242032							✓				

14 LED LAMPEN

LED Lampen Lucent Candle Filament



		#	W	= W	LM	LM/W	K						
B35 E14													
1	2.5 250LM 827	241593	2,5	25	250	100	2700	F	✓	360°	15,000	Ø35x97	
	2.5 250LM 827	241951	2,5	25	250	100	2700	F	✗	360°	15,000	Ø35x97	
2	4.1 350LM 822 Amber	240931	4,1	40	350	85	2200	F	✓	320°	15,000	Ø35x97	
	4.5 400LM 822 Amber	254643	4,5	40	400	89	2200	F		320°	15,000	Ø35x97	
3	4.5 470LM 827	241592	4,5	40	470	104	2700	F	✗	360°	15,000	Ø35x97	
	4.5 470LM 827	241952	4,5	40	470	104	2700	F	✓	360°	15,000	Ø35x97	
BA35 E14													
4	2.5 250LM 827	241953	2,5	25	250	100	2700	F	✗	360°	15,000	Ø35x123	
5	4.5 400LM 822 Amber	254644	4,5	40	400	89	2200	F	✓	320°	15,000	Ø35x123	
6	4.5 470LM 827	241954	4,5	40	470	104	2700	F	✓	360°	15,000	Ø35x123	



LED GASENTLADUNGSLAMPEN

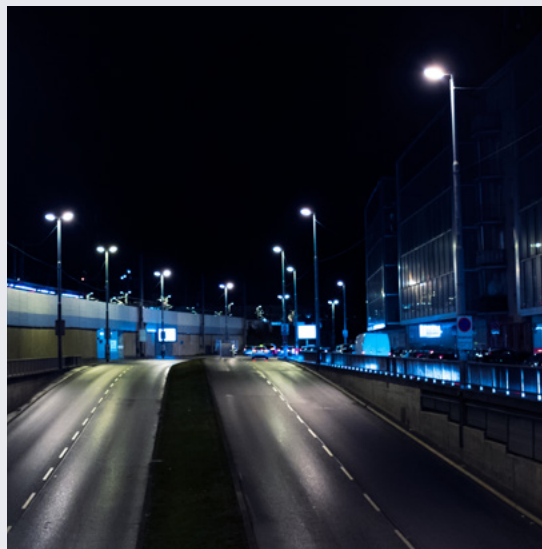

HID



HPL

WATT	18W - 36W	38W
LUMEN	2800 - 6000	7200 - 7500
LM/W	167	197
CRI	80	70
SOCKEL	E27 - E40	E40
FORM	HID	HPL
DIMMBAR	✗	✗
LEBENSDAUER L70	25,000h	25,000h
GARANTIE	3 Jahre	3 Jahre

14 LED GASENTLADUNGSLAMPEN

LED Lampen HID | KVG/Mains



-20~40°C
 CRI80
 3

		#	W	= W	LM	LM/W	K					
HID E27 KVG/Mains												
1	18W 2800LM 830	253952	18	50	2800	156	3000	D	X	330°	25,000	Ø75x180
	18W 3000LM 840	253953	18	50	3000	167	4000	C		330°	25,000	Ø75x180
HID E40 KVG/Mains												
2	36W 6000LM 840	253954	36	125	6000	167	4000	C	X	330°	25,000	Ø90x230

14 LED GASENTLADUNGSLAMPEN

LED Lampen HPL | KVG/Mains



#
W
= W
LM
LM/W
K

HPL E40 KVG/Mains												
#	W	= W	LM	LM/W	K							
38W 7200LM 730	253950	38	125	7200	189	3000	B	X	330°	25,000	Ø46x207	
38W 7500LM 740	253951	38	125	7500	197	4000	B		330°	25,000	Ø46x207	



LED ENERGIESPARLAMPEN PL



PL-C



PL-S



PL-L

WATT	3,6W - 7,4W	2,8W - 6W	7,9W - 11,9W
LUMEN	473 - 1000	368 - 805	950 - 1500
LM/W	136	139	126
CRI	80	80	80
SOCKEL	G24d	G23 - G27	G11
PINS	2	2 & 4	4
Vorschaltgerät	KVG/Mains	KVG/Mains	Elektronisch
DIMMBAR	✗	✗	✗
LEBENSDAUER L70	30,000h	30,000h	30,000h
GARANTIE	3 Jahre	3 Jahre	3 Jahre

15

LED ENERGIESPARLAMPEN PL

LED Lucent PL-C | KVG/Mains



2 Pins | KVG/Mains

1	3.6W 473LM 830 G24d-1 2P	248453	3,6	10	473	131	3000	E	X	120°	30,000	35x35x137
	3.6W 491LM 840 G24d-1 2P	248454	3,6	10	491	136	4000	D		120°	30,000	35x35x137
2	5.2W 650LM 830 G24d-2 2P	248469	5,2	18	650	125	3000	E		120°	30,000	36x36x148
	5.2W 700LM 840 G24d-2 2P	248470	5,2	18	700	134	4000	E		120°	30,000	36x36x148
3	7.4W 950LM 830 G24d-3 2P	248471	7,4	26	950	128	3000	E		120°	30,000	36x36x171
	7.4W 1000LM 840 G24d-3 2P	248472	7,4	26	1000	135	4000	D		120°	30,000	36x36x171

15

LED ENERGIESPARLAMPEN PL

LED Lucent PL-S | KVG/Mains



KEMA
KEUR

-20~40°C

CRI80

3

	#	W	= W	LM	LM/W	K						
2 Pins KVG/Mains												
1	2.8W 368LM 827 G23 2P	248455	2,8	5	368	131	2700	E	X	120°	30,000	21x32x136
	2.8W 368LM 830 G23 2P	248456	2,8	5	368	131	3000	E		120°	30,000	21x32x136
	2.8W 382LM 840 G23 2P	248457	2,8	5	382	136	4000	D		120°	30,000	21x32x136
2	4.3W 540LM 827 G23 2P	248458	4,3	9	540	125	2700	E		120°	30,000	21x32x167
	4.3W 540LM 830 G23 2P	248459	4,3	9	540	125	3000	E		120°	30,000	21x32x167
	4.3W 600LM 840 G23 2P	248460	4,3	9	600	139	4000	D		120°	30,000	21x32x167
3	6W 765LM 827 G23 2P	248464	6	11	765	127	2700	E		120°	30,000	21x32x237
	6W 765LM 830 G23 2P	248465	6	11	765	127	3000	E		120°	30,000	21x32x237
	6W 805LM 840 G23 2P	248468	6	11	805	134	4000	E		120°	30,000	21x32x237
4 Pins KVG/Mains												
4	4.3W 540LM 827 2G7 4P	248461	4,3	9	540	125	2700	E	X	120°	30,000	21x37x153
	4.3W 540LM 830 2G7 4P	248462	4,3	9	540	125	3000	E		120°	30,000	21x37x153
	4.3W 600LM 840 2G7 4P	248463	4,3	9	600	139	4000	D		120°	30,000	21x37x153
5	6W 765LM 827 2G7 4P	248466	6	11	765	127	2700	E		120°	30,000	21x37x222
	6W 765LM 830 2G7 4P	248467	6	11	765	127	3000	E		120°	30,000	21x37x222

15

LED ENERGIESPARLAMPEN PL

LED Lucent PL-L | Elektronisch



-20~40°C
 CRI180
 3

W = W LM LM/W K (mm)

4 Pins | Elektronisches Vorschaltgerät

1	7.9W 950LM 830	248443	7,9	18	950	120	3000	E	X	160°	30,000	37x23x224
	7.9W 1000LM 840	248444	7,9	18	1000	126	4000	E		160°	30,000	37x23x224
2	11.9W 1450LM 830	248441	11,9	24	1450	122	3000	E		160°	30,000	37x23x319
	11.9W 1500LM 840	248442	11,9	24	1500	126	4000	E		160°	30,000	37x23x319

Bitte überprüfen Sie die Noxion-Kompatibilitätsliste, um die Kompatibilität des Ersatzteils sicherzustellen.





LED STIFTSOCKELLAMPEN



G9



G4



GY6.35

WATT	1,9W - 4,8W	0,9W - 2W	2,6W
LUMEN	200 - 600	100 - 200	300
LM/W	125	111	115
CRI	80	80	80
SOCKEL	G9	G4	GY6.35
DIMMBAR	✗	✗	✗
LEBENSDAUER L70	15,000h	15,000h	15,000h
GARANTIE	3 Jahre	3 Jahre	3 Jahre

16

LED STIFTSOCKELLAMPEN

LED Lampen Bolt



🌡️ -20~40°C

CRI80

🕒 3

		#	W	= W	LM	LM/W	K					
C9												
1	1.9W 200LM 827	241796 254649	1,9	21	200	105	2700	F	✗	300°	15,000	ø16x52
2	3.2W 350LM 827	254646	3,2	32	350	109	2700	F	✓	300°	25,000	ø18x59
3	3.8W 470LM 827	241797 254650	3,8	40	470	123	2700	E	✗	300°	15,000	ø18x59
	3.8W 470LM 830	241801 254654								3000	E	300°
4	4.8W 600LM 827	241790 254647	4,8	48	600	125	2700	E		320°	15,000	ø18x59
	4.8W 600LM 830	254648								3000	E	320°
G4												
5	0.9W 100LM 827	241798 254651	0,9	10	100	90	2700	F	✗	320°	15,000	ø12x33
	0.9W 100LM 830	241802 254655								3000	F	320°
6	1.8W 200LM 827	254652	1,8	21	200	111	2700	F		320°	25,000	ø13x36
	1.8W 200LM 830	254653	1,8	21	200	111	3000	F		320°	15,000	ø13x36
7	2W 200LM 827	249469 254683	2	21	200	100	2700	F	✓	320°	15,000	ø15x40
GY6.35												
8	2.6W 300LM 830	249468 254682	2,6	28	300	115	3000	F	✗	320°	15,000	ø14x40





LED RÖHREN



**T8
Standard**



**T8
Extreme HO**



**T8
Extreme UO**



**T8
HF**



**T5
Extreme HF**



**T5
Extreme 230V**



WATT	7,5W - 19W	9W - 17W	9W - 23W	14W - 20W	16W - 37W	7W - 36W
EQUIVALENT	18W - 36W - 58W	18W - 30W - 36W - 58W	18W - 36W - 58W	36W - 58W	28W - 35W - 49W	14W - 54W
LUMEN	900 - 2300	1150 - 2700	1350 - 4100	1950 - 3100	2160 - 3900	1100 - 5600
LM/W	120	160	186	150	150	157
VORSCHALTGERÄT	KVG/Mains	KVG/Mains	KVG/Mains	Elektronisch	Elektronisch	Mains 230V
DIMMBAR	×	×	×	×	×	×
LEBENSDAUER L70	50,000h	50,000h	50,000h	50,000h	50,000h	50,000h
GARANTIE	5 Jahre	5 Jahre	5 Jahre	5 Jahre	5 Jahre	5 Jahre

17 LED RÖHREN

LED Röhren T8 Standard | KVG / Mains 230V



-10~45°C CRI80 5

	#	W	= W	LM	LM/W	K						
60cm Inklusive Starter												
1	7.5W 900LM 830	249086	7,5	18	900	120	3000	E	X	180°	50,000	604xø28
	7.5W 900LM 840	249087	7,5	18	900	120	4000	E				
	7.5W 900LM 865	249088	7,5	18	900	120	6500	E				
120cm Inklusive Starter												
2	15W 1800LM 830	249089	15	36	1800	120	3000	E	X	180°	50,000	1213xø28
	15W 1800LM 840	249090	15	36	1800	120	4000	E				
	15W 1800LM 865	249091	15	36	1800	120	6500	E				
150cm Inklusive Starter												
3	19W 2300LM 830	249092	19	58	2300	120	3000	E	X	180°	50,000	1514xø28
	19W 2300LM 840	249093	19	58	2300	120	4000	E				
	19W 2300LM 865	249094	19	58	2300	120	6500	E				
4	Starter Röhre T8 Standard (KVG/Mains)	237774										

17 LED RÖHREN

LED Röhren T8 Extreme HO | KVG / Mains 230V

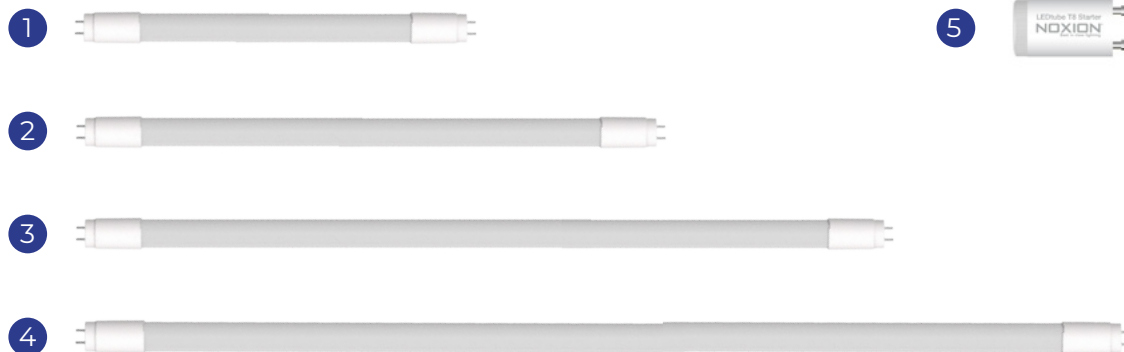

-10~45°C CRI80 5

		#	W	= W	LM	LM/W	K					
60cm Inklusive Starter												
1	8.2W 1150LM 827	249104	8,2	18	1150	140	2700	D	X	180°	50,000	604xø28
	8.2W 1150LM 830	249105	8,2	18	1150	140	3000	D				
	8.2W 1150LM 840	249106	8,2	18	1150	140	4000	D				
	8.2W 1150LM 865	249107	8,2	18	1150	140	6500	D				
90cm Inklusive Starter												
2	11.2W 1575LM 830	249108	11,2	30	1575	140	3000	D	X	180°	50,000	908.8xø28
	11.2W 1575LM 840	249109	11,2	30	1575	140	4000	D				
	11.2W 1575LM 865	249110	11,2	30	1575	140	6500	D				
120cm Inklusive Starter												
3	13W 2100LM 827	249111	13	36	2100	160	2700	C	X	180°	50,000	1213.6xø28
	13W 2100LM 830	249112	13	36	2100	160	3000	C				
	13W 2100LM 840	249113	13	36	2100	160	4000	C				
	13W 2100LM 865	249114	13	36	2100	160	6500	C				
150cm Inklusive Starter												
4	16.5W 2650LM 830	249116	16,5	58	2650	160	3000	C	X	180°	50,000	1500xø28
	16.5W 2650LM 840	249117	16,5	58	2650	160	4000	C				
	16.5W 2650LM 865	249118	16,5	58	2650	160	6500	C				
5	Starter Röhre T8 Standard (KVG/Mains)	237774										

17 LED RÖHREN

LED Röhren T8 Extreme UO | KVG / Mains 230V

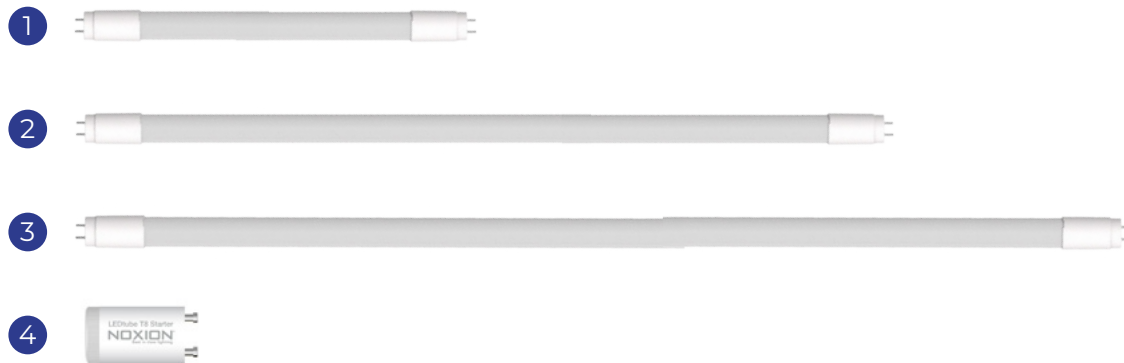

-10~45°C CRI80 5

	#	W	= W	LM	LM/W	K						
60cm Inklusive Starter												
1	8.4W 1350LM 830	249095	8,4	18	1350	160	3000	C	X	180°	50,000	604xø28
	8.4W 1350LM 840	249096	8,4	18	1350	160	4000	C				
	8.4W 1350LM 865	249097	8,4	18	1350	160	6500	C				
120cm Inklusive Starter												
2	15.9W 2550LM 830	249098	15,9	36	2550	160	3000	C	X	180°	50,000	1213xø28
	15.9W 2550LM 840	249099	15,9	36	2550	160	4000	C				
	15.9W 2550LM 865	249100	15,9	36	2550	160	6500	C				
150cm Inklusive Starter												
3	20.6W 3300LM 830	249101	20,6	58	3300	160	3000	C	X	180°	50,000	1514xø28
	20.6W 3300LM 840	249102	20,6	58	3300	160	4000	C				
	20.6W 3300LM 865	249103	20,6	58	3300	160	6500	C				
	22.1W 4100LM 840	255304	22,1	58	4100	186	4000	B				
	22.1W 4100LM 865	255305	22,1	58	4100	186	6500	B				
	23W 3500LM 830	254043	23	58	3500	152	3000	D				
	23W 3750LM 840	254044	23	58	3750	163	4000	C				
	23W 3750LM 865	254045	23	58	3750	163	6500	C				
4	Starter Röhre T8 Standard (KVG/Mains)	237774										

17 LED RÖHREN

LED Röhren T8 Extreme HO HF | Elektronisch



	#	W	= W	LM	LM/W	K						
120cm												
1	14W 1950LM 830	244316	14	36	1950	140	3000	E	X	190°	50,000	1212.5xø28
	14W 2100LM 840	244317	14	36	2100	150	4000	D				
	14W 2100LM 865	244318	14	36	2100	150	6500	D				
150cm												
2	20W 2800LM 830	244319	20	58	2800	140	3000	E	X	190°	50,000	1513.1xø28
	20W 3100LM 840	244320	20	58	3100	150	4000	D				
	20W 3100LM 865	244321	20	58	3100	150	6500	D				

Bitte überprüfen Sie die Noxion-Kompatibilitätsliste, um die Kompatibilität des Ersatzteils sicherzustellen.

17 LED RÖHREN

LED Röhren T5 Extreme HE / HO HF | Elektronisch



		#	W	= W	LM	LM/W	K						
55cm													
1	7.5W 1050LM 830	255468	7,5	14	1050	140	3000	E	X	≤180°	60,000	563xø18	
	7.5W 1100Lm 840	255469	7,5	14	1100	146	4000	E					
115cm													
2	16W 2160LM 830	245197	16	28	2160	135	3000	E	X	≤180°	50,000	1163xø18	
	16W 2400LM 840	245198	16	28	2400	150	4000	D					
	16W 2400LM 865	245199	16	28	2400	150	6500	D					
	26W 3700LM 830	255470	26	54	3700	142	3000	E					
	26W 3900LM 840	255471	26	54	3900	150	4000	D					
										60,000			
145cm													
3	19W 2610LM 830	249042	19	35	2610	113	3000	E	X	≤180°	50,000	1463xø18	
	19W 2900LM 830	249043	19	35	2900	152	4000	D					
	19W 2900LM 830	249044	19	35	2900	152	6500	D					
	26W 3510LM 830	245200	26	49	3510	135	3000	E					
	26W 3900LM 840	245201	26	49	3900	150	4000	D					
	26W 3900LM 865	245202	26	49	3900	150	6500	D					
	37W 5600LM 840	255472	37	80	5600	150	4000	D					
										60,000			

Bitte überprüfen Sie die Noxion-Kompatibilitätsliste, um die Kompatibilität des Ersatzteils sicherzustellen.

17 LED RÖHREN

LED Röhren T5 Extreme HE / HO | Mains 230V

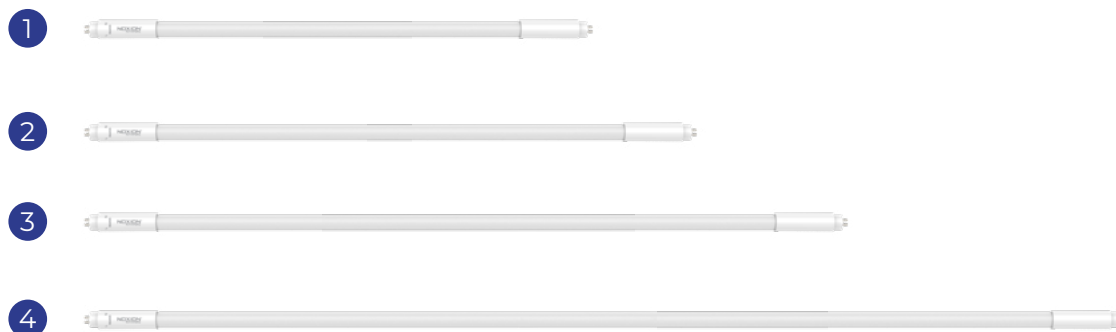

-20~45°C
 CRI80
 5

		#	W	= W	LM	LM/W	K						
55cm													
1	7W 1100LM 840	255473	7	14	1100	157	4000	D	×	≤180°	50,000	549xø19	
85cm													
2	18W 2800LM 840	255474	18	39	2800	150	4000	D	×	≤180°	50,000	849xø19	
115cm													
3	16W 2300LM 830	255475	16	28	2300	143	3000	D	×	≤180°	50,000	1149xø19	
	16W 2400LM 840	255476	16	28	2400	150	4000	D					
	26W 3640LM 830	247466	26	54	3640	140	3000	D					
	26W 3900LM 840	246504	26	54	3900	150	4000	D					
	26W 3900LM 865	246505	26	54	3900	150	6500	D					
145cm													
4	26W 3640LM 830	246506 247467	26	49	3640	140	3000	D	×	≤180°	50,000	1449xø19	
	26W 3900LM 840	246507	26	49	3900	150	4000	D					
	26W 3900LM 865	246508	26	49	3900	150	6500	D					
	36W 5600LM 840	255477	36	49	5600	155	4000	D					



NOXION

LED Dimmer

300W-50Hz
RI-0-300W RC-0-300W LED

Automatic

nIM

CE

LED ZUBEHÖR

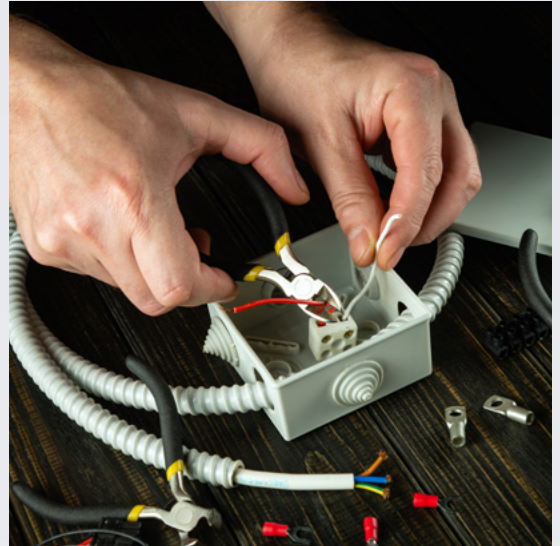

18 LED ZUBEHÖR

LED Dimmer



1



2



3



4

3

		#	⚡	⚡	DM	LED	HL	INC
1	LED Automatischer Dimmer Schalter RLC 0-300W 220-240V	238453	300W/VA	0W/VA	Phasen-/abschnitt	RC:0-300W RL:0-200W	10-300W/VA	10-300W/VA
	LED Automatischer Dimmer Schalter RC 0-150W 230V	248985	150W/VA	0W/VA	abschnitt	RC:0-150W	10-300W/VA	10-300W/VA
2	LED Cord Dimmer Schalter RLC 0-50W 220-240V	238539	50W/VA	0W/VA	Phasen-/abschnitt	RLC:0-50W	0-100W/VA	0-100W/VA
	Schaltanlagenabdeckung							
3	Drehbare Abdeckplatte für LED Dimmer Weiche Kante - Weiß	238540						
4	Drehbare Abdeckplatte für LED Dimmer Harte Kante - Weiß	238541						

18 LED ZUBEHÖR

Kabel & Sonstiges

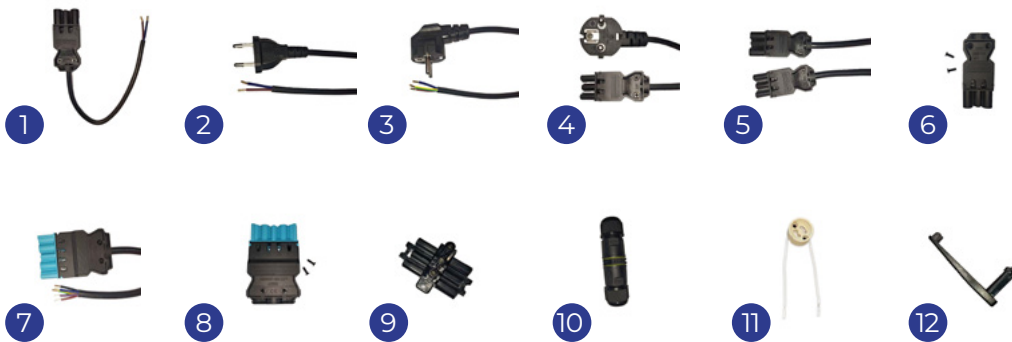

		#
1	Kompatibel Versorgungskabel - Männlich + Offene Enden - Schwarz 0,3m - 2 polig 0,75mm ²	252483
	Kompatibel Versorgungskabel - Männlich + Offene Enden - Schwarz 0,3m - 3 polig 0,75mm ²	252484
	Kompatibel Versorgungskabel - Männlich + Offene Enden - Schwarz 2m - 3 polig 0,75mm ²	252485
	Kompatibel Versorgungskabel - Männlich + Offene Enden - Schwarz 3m - 3 polig 0,75mm ²	252486
2	Kompatibel Versorgungskabel - C7 Europlug + Offene Enden - Weiß 2m - 2 polig 0,75mm ²	252509
	Kompatibel Versorgungskabel - C7 Europlug + Offene Enden - Schwarz 2m - 2 polig 0,75mm ²	252510
3	Kompatibel Versorgungskabel - Shuko Europlug + Offene Enden - Schwarz 2m - 3 polig 0,75mm ²	252506
	Kompatibel Versorgungskabel - Shuko Europlug + Offene Enden - Schwarz 3m - 3 polig 0,75mm ²	252507
	Kompatibel Versorgungskabel - Shuko Europlug + Offene Enden - Schwarz 5m - 3 polig 0,75mm ²	252508
4	Kompatibel Versorgungskabel - Weiblich + Shuko Europlug - Schwarz 2m - 3 polig 0,75mm ²	252489
	Kompatibel Versorgungskabel - Weiblich + Shuko Europlug - Schwarz 3m - 3 polig 0,75mm ²	252490
5	Kompatibel Verlängerungskabel - Männlich + Weiblich - Schwarz 1m - 3 polig 1,5mm ²	252477
	Kompatibel Verlängerungskabel - Männlich + Weiblich - Schwarz 1,5m - 3 polig 1,5mm ²	252478
	Kompatibel Verlängerungskabel - Männlich + Weiblich - Schwarz 2m - 3 polig 1,5mm ²	252479
	Kompatibel Verlängerungskabel - Männlich + Weiblich - Schwarz 3m - 3 polig 1,5mm ²	252480
	Kompatibel Verlängerungskabel - Männlich + Weiblich - Schwarz 5m - 3 polig 1,5mm ²	252481
6	Kompatibel Verlängerungskabel - Männlich + Weiblich - Pastel Blau 3m - 5 polig 1,5mm ²	252504
	Kompatibel Verbinder - Männlich - Schwarz - 3 polig	252492
7	Kompatibel Versorgungskabel - Männlich + Offene Enden - Schwarz 0,3m - 5 polig 0,75mm ²	252498
	Kompatibel Versorgungskabel - Männlich + Offene Enden - Schwarz 2m - 5 polig 0,75mm ²	252499
8	Kompatibel Verbinder - Männlich - Pastel Blau - 5 polig	252496
	Kompatibel Verbinder - Weiblich - Pastel Blau - 5 polig	252497
9	Kompatibel T Verbinder - 1 Männlich + 2 Weiblich - Schwarz - 3 polig 1,5mm ²	252482
	Kompatibel T Verbinder - 1 Männlich + 2 Weiblich - Schwarz - 5 polig	252494
	Kompatibel Distributor - 1 Männlich + 5 Weiblich - Schwarz - 3 polig 1,5mm ²	252493
10	Wasserdicht Quick Kabel Verbinder - Schwarz - 3 polig	252512
	Wasserdicht Quick Kompatibel T Verbinder - Schwarz - 3 polig	252513
11	GU10 Socket - Universal GU10 Kompatibel - Weiß 0,1m - 2 polig 0,5mm ²	252511
12	Kompatibel Zugentlastung - Schwarz	252495
	Zugentlastung Junctionbox mit Terminal block - Schwarz - 3 polig	252514

IHRE VORTEILE ALS PROFESSIONAL

Als BeleuchtungDirekt Pro Kunde bieten wir Ihnen exklusive Vorteile, die Ihre Arbeit als Installateur noch einfacher machen und Ihre Beleuchtungsprojekte schneller zum Abschluss bringen. So profitieren Sie zum Beispiel von der technischen Projektunterstützung durch unsere Beleuchtungsexperten, der persönlichen Kommunikation mit Ihrem eigenen Account Manager und vielem mehr! Unsere Dienstleistungen und zusätzlichen Webshop-Funktionen sind darauf ausgerichtet, Ihnen Kosten und Zeit zu sparen und Ihnen die Unterstützung zu geben, die Sie wirklich brauchen.

Individuelle Produkte & Beschaffung

Wenn Sie eine große Abnahmemenge benötigen, arbeiten wir mit Ihnen zusammen, um individuelle Beleuchtungslösungen zu entwickeln, die genau Ihren Anforderungen entsprechen. Mit unserer eigenen Marke Noxion können wir maßgeschneiderte Produkte entwickeln, die Ihre oder die spezifischen Anforderungen Ihrer Kunden erfüllen. Dabei profitieren Sie von den Kenntnissen unserer über 30 Beleuchtungsexperten. Wenden Sie sich an Ihren persönlichen Account Manager, um Lichtlösungen zu entwickeln, die Ihren Vorstellungen und technischen Anforderungen entsprechen. Diese werden in unserer eigenen Noxion-Fabrik hergestellt. Auf diese Weise können Sie Ihren Kunden maßgefertigte Beleuchtungslösungen anbieten, mit denen Sie sich von der Konkurrenz abheben.

Mit dem Know-how von Noxion und unserem Engagement für Innovation helfen wir Ihnen, jedes Mal außergewöhnliche Ergebnisse zu erzielen. Lassen Sie uns gemeinsam etwas Großartiges schaffen!



Produktmuster anfordern & testen

Wenn Sie sich für ein bestimmtes Produkt interessieren und sehen möchten, ob es Ihren Bedürfnissen, Anforderungen und Ihrem Projekt entspricht, sind Sie bei uns genau richtig!

Mit einem Produktmuster können Sie die Qualität, die Funktionalität und die Kompatibilität des Produkts mit Ihrem Projekt testen, bevor Sie eine große Bestellung aufgeben. So können Sie sichergehen, dass Sie genau das bekommen, was Sie brauchen. Und dank Ihrer praktischen Erfahrung können Sie Ihren Kunden bessere Empfehlungen geben. Auf diese Weise können Sie ohne Risiko sicherstellen, dass Sie die perfekte Lösung für Ihre Projekte finden. Wenden Sie sich einfach an Ihren persönlichen Account Manager und er kümmert sich um den Rest!

Technischer Beleuchtungssupport

Wenn Sie sich nicht sicher sind, welche Beleuchtung für Ihr Projekt am besten geeignet ist, können Sie uns die Aufgabe überlassen. Unsere Lichtexperten kümmern sich um alles, von der Beleuchtungsberechnung bis hin zum vollständigen Angebot. Wir antworten Ihnen so schnell wie möglich, damit Sie mit Ihrem Projekt fortfahren können und Ihre Kunden nicht warten müssen.

Neutraler Lieferschein

Wir verstehen die Bedürfnisse von Installateuren. Deshalb bieten wir Ihnen die Möglichkeit, neutrale Lieferscheine für Ihre Bestellungen zu verwenden. Dies hat folgenden Vorteil:

- **Professionelle Außendarstellung:** Mit unserem neutralen Lieferschein können Sie die Produkte direkt an Ihre Kunden liefern, ohne uns als Lieferant preiszugeben
- **Kundenvertrauen:** Der neutrale Lieferschein stärkt Ihre Position als Experte und Anbieter und erhöht das Vertrauen der Kunden in Sie.
- **Optimierte Logistik:** Sparen Sie Zeit und Ressourcen, indem Sie uns direkt an Ihre Kunden liefern lassen. Sie profitieren von mehr Platz im eigenen Lager.























Ein fester persönlicher Account Manager

Als Pro Kunde werden Sie von Ihrem persönlichen Account Manager unterstützt, der Ihnen bei jedem Schritt schnell, aufmerksam und vertrauensvoll zur Seite steht. Er kommuniziert stets in Ihrer Muttersprache und sorgt dafür, dass jede Zusammenarbeit transparent und jedes Projekt reibungslos verläuft.

Ihr persönlicher Account Manager sorgt dafür, dass alle Ihre Fragen in Lichtgeschwindigkeit beantwortet werden, um Ihre eigene Zufriedenheit und die Ihrer Kunden zu gewährleisten!

SYMBOLS UND INFORMATIONEN

	Modell		3 Stunden Notbeleuchtung		PIR Sensor
	Art.-Nr.		Ladezeit		Dimmbar 0-10V
	EAN		Batterie		Material - GRP
	Watt		Ausschnittgröße		Watt-Schalter
	Äquivalent		Schwenkbar		Neues Produkt
	Lumen		Deckenmontage		Multi-CCT
	Effizienz		Einbaumontage		
	Kelvin		Energielabel		
	Dimmbar		Max Last		
	Abstrahlwinkel		Min Last		
	Lebensdauer		Max/Min Last		
	Produktgröße (mm)		Art der Last		
	Garantie (Jahre)		Dimmfunktion		
	Farbwiedergabeindex		Dimmbare LED		
	Schutz gegen Stöße		Alle Beleuchtungsarten		
	Schutz gegen Wasser & Staub		Kontrollmodus		
	Optionale Funktionen		Leistungsbereich		
	Produktgröße (Zeichnung)		Kabelabschnitt		
	Betriebstemperatur		Philips Xitanium Treiber		
	Lichttechnisches Diagramm		DALI		
	Durchgangsver- drahtung 5x		Tageslichtsensor		
	Durchgangsver- drahtung 2x		Bewegungssensor		
	Optionales Feature		Optionaler Abstrahlwinkel		

www.noxion.com info@noxion.com

PICPAC B.V. Hooge Zijde 30
5626 DC Eindhoven, The Netherlands
+31 (0)85 - 303 29 82

Zollstockgürtel 63
50969 Köln, Deutschland
+49 221 82828069

2026

NOXION[®]
Best in class lighting

©2026 PICPAC B.V. – Alle Rechte vorbehalten. Angaben können ohne vorherige Ankündigung geändert werden. Noxion behält sich das Recht vor, Produktspezifikationen ohne Ankündigung oder Verpflichtung zu ändern, und übernimmt keine Verantwortung für die Folgen der Nutzung dieses Dokuments. Irrtümer und Druckfehler vorbehalten.